



# EnergyPlus Testing with ANSI/ASHRAE Standard 140-2001 (BESTEST)

EnergyPlus Version 1.2.0.029

June 2004

---

Ernest Orlando Lawrence Berkeley National Laboratory  
Berkeley, California

for

U.S. Department of Energy  
Office of the Building Technologies Program  
Energy Efficiency and Renewable Energy  
Washington, D.C.



Prepared by:

Robert H. Henninger and Michael J. Witte

**GARDAnalytics**

*Energy, Economic and Environmental Research*

1028 Busse Highway  
Park Ridge, Illinois 60068  
USA  
[www.gard.com](http://www.gard.com)



## Table of Contents

Section	Page
<b>1 TEST OBJECTIVES AND OVERVIEW</b> .....	<b>1</b>
1.1 Test Type: Comparative - Loads .....	1
1.2 Test Suite: ANSI/ASHRAE Standard 140-2001 (BESTEST) .....	1
1.2.1 Case 600 – Base Case Low Mass Building.....	3
1.2.2 Case 610 – South Shading Test for Low Mass Building .....	6
1.2.3 Case 620 – East/West Window Orientation Test for Low Mass Building.....	7
1.2.4 Case 630 – East/West Shading Test for Low Mass Building.....	8
1.2.5 Case 640 – Thermostat Setback Test for Low Mass Building.....	8
1.2.6 Case 650 – Night Ventilation Test for Low Mass Building.....	9
1.2.7 Case 900 –Base Case High Mass Building .....	10
1.2.8 Case 910 –South Shading Test for High Mass Building.....	10
1.2.9 Case 920 – East/West Window Orientation Test for High Mass Building.....	11
1.2.10 Case 930 – East/West Shading Test for High Mass Building.....	11
1.2.11 Case 940 – Thermostat Setback Test for High Mass Building.....	11
1.2.12 Case 950 – Night Ventilation Test for High Mass Building .....	11
1.2.13 Case 960 – Sunspace Test .....	11
1.2.14 Case 600FF – Free Floating Temperature Test for Base Case Low Mass Building .....	12
1.2.15 Case 650FF – Free Floating Temperature Test for Base Case Low Mass Building with Night Ventilation .....	12
1.2.16 Case 900FF – Free Floating Temperature Test for Base Case High Mass Building.....	13
1.2.17 Case 950FF – Free Floating Temperature Test for Base Case High Mass Building with Night Ventilation .....	13
1.2.18 Case 195 – Indepth Test of Solid Conduction Problem for Low Mass Building .....	13
1.3 Modeling Notes .....	13
<b>2 RESULTS AND DISCUSSION</b> .....	<b>15</b>
2.1 Comparison of Changes that Occurred Between Versions of EnergyPlus.....	17
<b>3 CONCLUSIONS</b> .....	<b>19</b>
<b>4 REFERENCES</b> .....	<b>21</b>

## Table of Contents

<b>Section</b>	<b>Page</b>
<b>APPENDIX A CHARTS COMPARING ENERGYPLUS RESULTS WITH OTHER WHOLE BUILDING ENERGY SIMULATION PROGRAMS</b>	
<b>APPENDIX B TABLES COMPARING ENERGYPLUS RESULTS WITH OTHER WHOLE BUILDING ENERGY SIMULATION PROGRAMS</b>	
<b>APPENDIX C DELTA CHARTS COMPARING ENERGYPLUS RESULTS WITH OTHER WHOLE BUILDING ENERGY SIMULATION PROGRAMS</b>	
<b>APPENDIX D HISTORICAL CHANGES IN BESTEST RESULTS FOR VARIOUS RELEASES OF ENERGYPLUS</b>	
<b>APPENDIX E ANSI/ASHRAE STANDARD 140-2001 OUTPUT FORM – MODELING NOTES</b>	

# 1 TEST OBJECTIVES AND OVERVIEW

---

## 1.1 Test Type: Comparative - Loads

Comparative tests compare a program to itself or to other simulation programs. This type of testing accomplishes results on two different levels, both validation and debugging.

From a validation perspective, comparative tests will show that EnergyPlus is computing solutions that are reasonable compared to other energy simulation programs. This is a very powerful method of assessment, but it is no substitute for determining if the program is absolutely correct since it may be just as equally incorrect as the benchmark program or programs. The biggest strength of comparative testing is the ability to compare any cases that two or more programs can model. This is much more flexible than analytical tests when only specific solutions exist for simple models, and much more flexible than empirical tests when only specific data sets have been collected for usually a very narrow band of operation. The ANSI/ASHRAE Standard 140-2001 procedures discussed below take advantage of the comparative test method and have the added advantage that for the specific tests included in ANSI/ASHRAE Standard 140-2001 have already been run by experts of the other simulation tools.

Comparative testing is also useful for field-by-field input debugging. Energy simulation programs have so many inputs and outputs that the results are often difficult to interpret. To ascertain if a given test passes or fails, engineering judgment or hand calculations are often needed. Field by field comparative testing eliminates any calculational requirements for the subset of fields that are equivalent in two or more simulation programs. The equivalent fields are exercised using equivalent inputs and relevant outputs are directly compared.

## 1.2 Test Suite: ANSI/ASHRAE Standard 140-2001 (BESTEST)

The tests described in ANSI/ASHRAE Standard 140-2001, *Standard Method of Test for the Evaluation of Building Energy Analysis Computer Programs* (ANSI/ASHRAE 2001) were performed. As stated in its Foreword, Standard 140-2001 is a standard method of test that “can be used for identifying and diagnosing differences in predictions for whole building energy simulation software that may possibly be caused by software errors. The current set of tests included here consists of comparative tests that focus on building envelope loads.” When necessary, additional information was provided by the IEA 12B/21C sponsored report, *Building Energy Simulation Test (BESTEST) and Diagnostic Method* (IEA 1995), which served as the basis for the ANSI/ASHRAE standard.

The following tests were performed as specified with modeling notes and other reports generated as shown in the Standard:

- Base test (Case 600, Section 5.2.1 of Standard)
- Basic tests (Section 5.2.2 of Standard)
  - Low mass tests (Cases 610 to 650),
  - High mass tests (Cases 900 to 960)
  - Free float tests (Cases 600FF, 650FF, 900FF and 950FF)

The in-depth tests (Section 5.2.3 of Standard) which include tests 195 to 320, 395 to 440, 800 and 810 are intended to be used in diagnosing specific differences found in various algorithms in the simulation program. The following in-depth tests were performed:

- Case 195 – Solid Conduction Problem

The EnergyPlus test results are compared to the results of all programs that completed and reported test results, including ESP, BLAST-3-193, DOE2.1D, SRES/SUN, SERIRES, S3PAS, TRNSYS and TASE. Although not part of the original BESTEST set of results, results for later versions of BLAST and DOE2 have also been added for completeness -- BLAST-3.0-334 and DOE2.1E.

### 1.2.1 Case 600 – Base Case Low Mass Building

The basic test building (Figure 1) is a rectangular single zone (8 m wide x 6 m long x 2.7 m high) with no interior partitions and 12 m<sup>2</sup> of windows on the south exposure. The building is of lightweight construction with characteristics as described below. For further details refer to Section 5.2.1 of ANSI/ASHRAE Standard 140-2001.

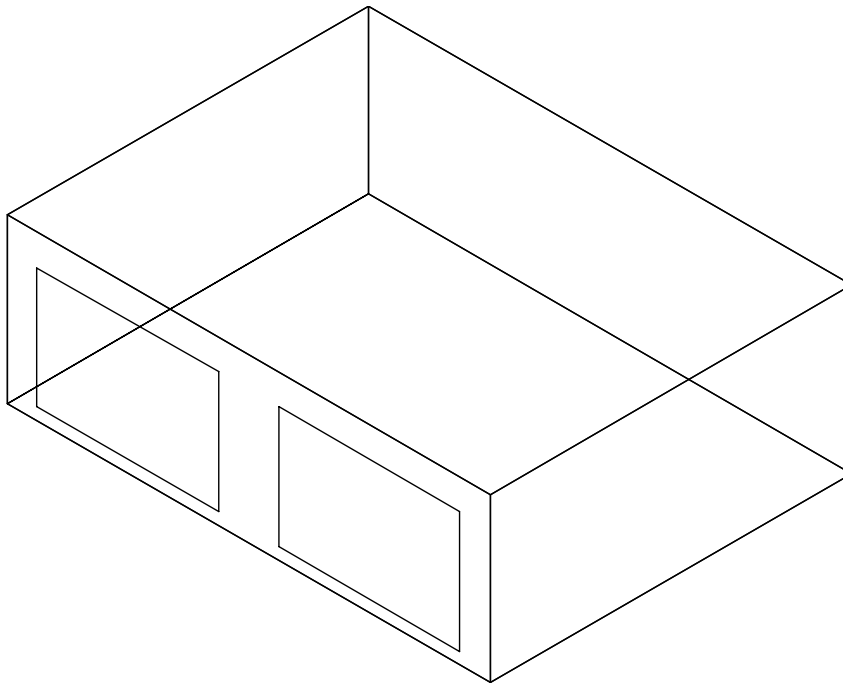

**Figure 1 Base Building (Case 600) - Isometric View of Southeast Corner with Windows on South Wall**

#### Wall Construction (light weight mass)

Element	k (W/m-K)	Thickness (m)	U (W/m <sup>2</sup> -K)	R (m <sup>2</sup> -K/W)	Density (kg/m <sup>3</sup> )	Cp (J/kg-K)
Int. Surface Coeff.			8.290	0.121		
Plasterboard	0.160	0.012	13.333	0.075	950	840
Fiberglass Quilt	0.040	0.066	0.606	1.650	12	840
Wood Siding	0.140	0.009	15.556	0.064	530	900
Ext. Surface Coeff.			29.300	0.034		
Overall, air-to-air			0.514	1.944		

### Roof Construction (light weight mass)

Element	k (W/m-K)	Thickness (m)	U (W/m <sup>2</sup> -K)	R (m <sup>2</sup> -K/W)	Density (kg/m <sup>3</sup> )	Cp (J/kg-K)
Int. Surface Coeff.			8.290	0.121		
Plasterboard	0.160	0.010	16.000	0.063	950	840
Fiberglass Quilt	0.040	0.1118	0.358	2.794	12	840
Roof Deck	0.140	0.019	7.368	0.136	530	900
Ext. Surface Coat			29.300	0.034		
Overall, air-to-air			0.318	3.147		

### Floor Construction (light weight mass)

Element	k (W/m-K)	Thickness (m)	U (W/m <sup>2</sup> -K)	R (m <sup>2</sup> -K/W)	Density (kg/m <sup>3</sup> )	Cp (J/kg-K)
Int. Surface Coeff.			8.290	0.121		
Timber Flooring	0.140	0.025	5.600	0.179	650	1200
Insulation	0.040	1.003	0.040	25.075		
Overall, air-to-air			0.039	25.374		

### Window Properties

Extinction coefficient	0.0196/mm
Number of panes	2
Pane thickness	3.175 mm
Air-gap thickness	13 mm
Index of refraction	1.526
Normal direct-beam transmittance through one pane	0.86156
Thermal Conductivity of glass	1.06 W/mK
Conductance of each glass pane	333 W/m <sup>2</sup> K
Combined radiative and convective coefficient of air gap	6.297 W/ m <sup>2</sup> K
Exterior combined surface coefficient	21.00 W/ m <sup>2</sup> K
Interior combined surface coefficient	8.29 W/ m <sup>2</sup> K
U-value from interior air to ambient air	3.0 W/ m <sup>2</sup> K
Hemispherical infrared emittance of ordinary uncoated glass	0.9
Density of glass	2500 kg/m <sup>3</sup>
Specific heat of glass	750 J/kgK
Interior shade devices	None
Double-pane shading coefficient at normal incidence	0.907
Double-pane solar heat gain coefficient at normal incidence	0.789



There is 0.2 m of wall below the window and 0.5 m of wall above the window.

Windows are described in EnergyPlus using the Windows 5 format. Additional glass properties are required for the front side and back side. In consultation with F. Winkelmann of LBNL, it was recommended that the window described above for the ANSI/ASHRAE Standard 140-2001 test be modeled as follows in EnergyPlus:

MATERIAL:WINDOWGLASS,

Glass Type 1, !A1 [NAME] BESTEST CLEAR 1/8 IN  
SpectralAverage, !A2 [Optical data type {SpectralAverage or Spectral}]  
, !A3 [Name of spectral data set when Optical Data Type = Spectral].  
MATERIAL:WINDOWGLASS, BESTEST CLEAR 1/8 IN  
0.003175, !N1 [Thickness {m}] 1/8"  
0.86156, !N2 [Solar transmittance at normal incidence]  
0.07846, !N3 [Solar reflectance at normal incidence: front side, calc  
from n=1.526, Tsol=.86156]  
0.07846, !N4 [Solar reflectance at normal  
incidence: back side]  
0.91325, !N5 [Visible transmittance at normal  
incidence, scaled from Window4 ID=1]  
0.08200, !N6 [Visible reflectance at normal incidence: front side, based  
on Window4 ID=14]  
0.08200, !N7 [Visible reflectance at normal incidence: back side]  
0.0, !N8 [IR transmittance at normal incidence]  
0.84, !N9 [IR emittance: front side]  
0.84, !N10 [IR emittance: back side]  
1.06; !N11 [Conductivity {W/m-K}]

MATERIAL:WINDOWGAS,

Air Space Resistance, !A1 [Name] BESTEST AIR GAP 1/2 IN  
AIR, !A2 [Gas type (Air - Argon - Krypton - Xenon - SF6 - Custom)]  
0.013; !N1 [Gap width {m}] 1/2 inch

CONSTRUCTION, BESTEST DOUBLE PANE, ! Material layer names follow:

Glass Type 1,  
Air Space Resistance,  
Glass Type 1;

**Infiltration:** 0.5 air change/hour

**Internal Load:** 200 W continuous, 60% radiative, 40% convective, 100% sensible

**Mechanical System:** 100% convective air system, 100% efficient with no duct losses and no capacity limitation, no latent heat extraction, non-proportional-type dual setpoint thermostat with deadband, heating  $<20^{\circ}\text{C}$ , cooling  $>27^{\circ}\text{C}$

**Soil Temperature:** 10C continuous

### ***1.2.2 Case 610 – South Shading Test for Low Mass Building***

Case 610 uses the Base Building modeled in Case 600 and adds a 1 m horizontal overhang across the entire length of south wall over the south facing windows at the roof level. See Figure 2. All other characteristics of the building were identical to the Base Case building. This case tests the ability of a program to treat shading of a south exposed window.

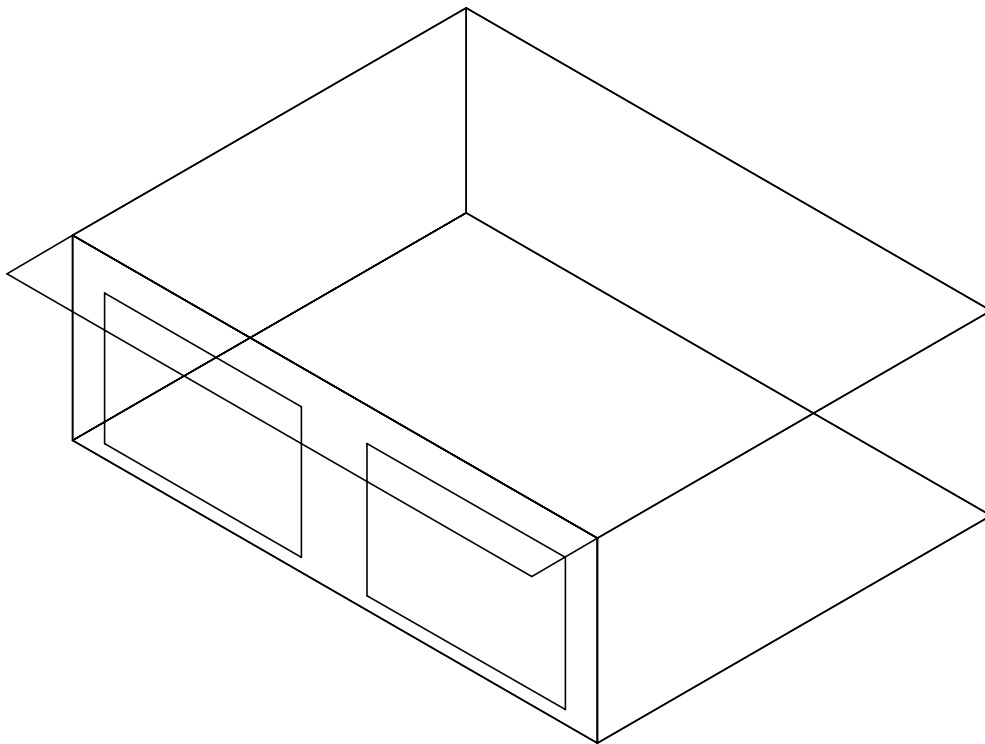
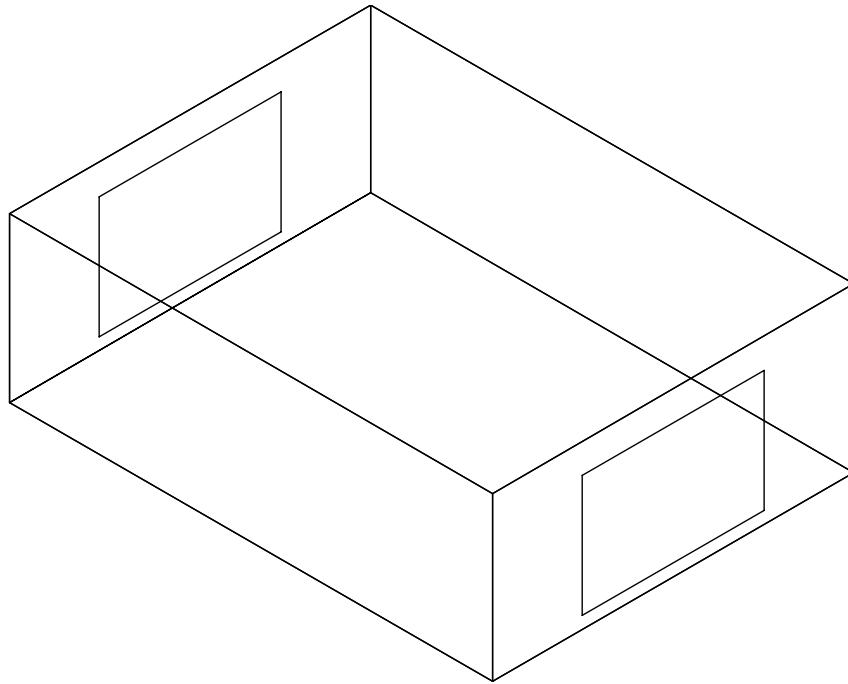

**Figure 2 Base Building with South Shading (Case 610) -  
Isometric View of Southeast Corner**

### ***1.2.3 Case 620 – East/West Window Orientation Test for Low Mass Building***

Case 620 uses the Base Building modeled in Case 600 with the following changes:

- a) The window orientation was modified as shown in Figure 3 such that 6 m<sup>2</sup> of window area was added to both the east and west walls. The window properties are exactly the same as in Case 600
- b) The south windows were eliminated and replaced with the wall construction used throughout the building



**Figure 3 Building with East/West Window Orientation (Case 620) -  
Isometric View of Southeast Corner**

#### ***1.2.4 Case 630 – East/West Shading Test for Low Mass Building***

Case 630 is exactly the same as Case 620 except that a shade overhang and shade fins were added around the east and west window. See Figure 4. A 1 m horizontal overhang is located at the roof level and extends across the 3 m width of each window. The 1 m wide right and left vertical shade fins are located a edge of each window and extend from the roof down to the ground.

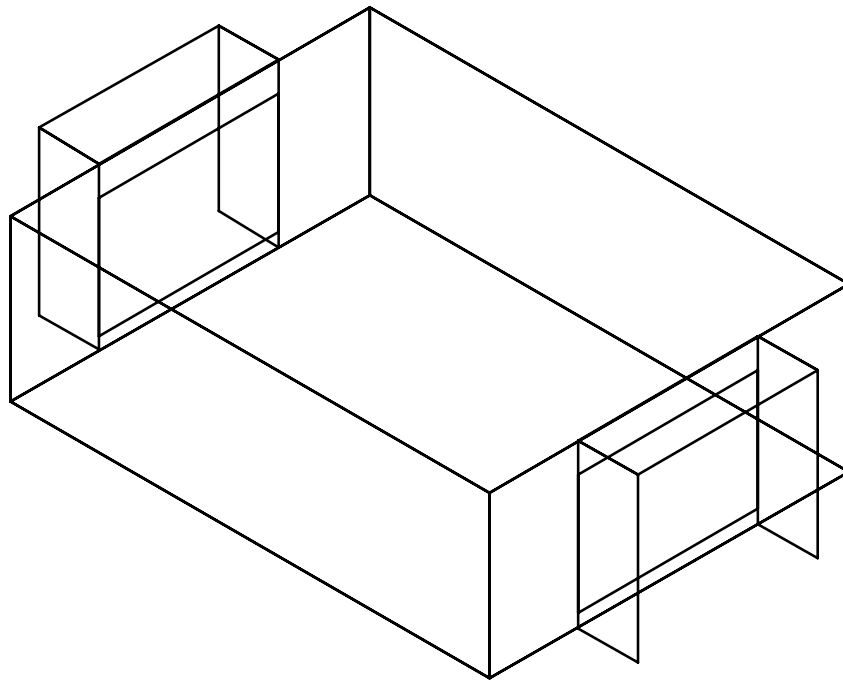

**Figure 4 Building with East/West Window Orientation and Shade Overhang and Shade Fins added (Case 630) - Isometric View of Southeast Corner**

#### ***1.2.5 Case 640 – Thermostat Setback Test for Low Mass Building***

Case 640 is identical to the Base Case building of Case 600 except the following heating and cooling temperature setback schedule with a non-proportional thermostat was used:

- a) From 2300 hours to 0700 hours, heat = on if zone temperature  $<10^{\circ}\text{C}$
- b) From 0700 hours to 2300 hours, heat = on if zone temperature  $<20^{\circ}\text{C}$
- c) All hours, cool = on if zone temperature  $>27^{\circ}\text{C}$
- d) Otherwise, mechanical equipment is off.

See Figure 1 for schematic of building.

### ***1.2.6 Case 650 – Night Ventilation Test for Low Mass Building***

Case 650 is identical to the Base Case building of Case 600 except the following scheduled night time ventilation and heating and cooling temperature control was used:

- a) From 1800 hours to 0700 hours, vent fan = on
- b) From 0700 hours to 1800 hours, vent fan = off
- c) Heating is always off
- d) From 0700 hours to 1800 hours, cool = on if zone temperature  $>27^{\circ}\text{C}$ , otherwise cool = off
- e) From 1800 hours to 0700 hours, cool = off
- f) Vent fan capacity = 1703.16 standard  $\text{m}^3/\text{h}$  (in addition to specified infiltration rate)
- g) Waste heat from fan = 0.

See Figure 1 for schematic of building.

### 1.2.7 Case 900 –Base Case High Mass Building

The 900 series of tests use the same building model as was used for the series 600 tests except that the wall and floor construction were changed to use heavier materials. Everything else with the building remained the same. The characteristics of the heavier mass wall and floor are as follows:

#### Wall Construction (heavy weight mass)

Element	k (W/m-K)	Thickness (m)	U (W/m <sup>2</sup> -K)	R (m <sup>2</sup> -K/W)	Density (kg/m <sup>3</sup> )	Cp (J/kg-K)
Int. Surface Coeff.			8.290	0.121		
Concrete Block	0.510	0.100	5.100	0.196	1400	1000
Foam Insulation	0.040	0.0615	0.651	1.537	10	1400
Wood Siding	0.140	0.009	15.556	0.064	530	900
Ext. Surface Coeff.			29.300	0.034		
Overall, air-to-air			0.512	1.952		

#### Floor Construction (heavy weight mass)

Element	k (W/m-K)	Thickness (m)	U (W/m <sup>2</sup> -K)	R (m <sup>2</sup> -K/W)	Density (kg/m <sup>3</sup> )	Cp (J/kg-K)
Int. Surface Coeff.			8.290	0.121		
Concrete Slab	1.130	0.080	14.125	0.071	1400	1000
Insulation	0.040	1.007	0.040	25.175		
Overall, air-to-air			0.039	25.366		

See Figure 1 for schematic of building for Case 900.

### 1.2.8 Case 910 –South Shading Test for High Mass Building

Case 910 uses the high mass Base Building modeled in Case 900 except that a 1 m horizontal overhang was added to the entire length of south wall over the south facing windows at the roof level. See Figure 2. All other characteristics of the building were identical to the high mass Base Building of Case 900. This case tests the ability of a program to treat shading of a south exposed window. This case is identical to Case 610 except for high mass walls and floor.

### ***1.2.9 Case 920 – East/West Window Orientation Test for High Mass Building***

Case 920 is identical to Case 620 except for high mass walls and floor.

### ***1.2.10 Case 930 – East/West Shading Test for High Mass Building***

Case 930 is identical to Case 630 except for high mass walls and floor.

### ***1.2.11 Case 940 – Thermostat Setback Test for High Mass Building***

Case 940 is identical to Case 640 except for high mass walls and floor.

### ***1.2.12 Case 950 – Night Ventilation Test for High Mass Building***

Case 950 is identical to case 650 except for high mass walls and floor.

### ***1.2.13 Case 960 – Sunspace Test***

Case 960 simulates a passive solar building consisting of two zones (a back-zone and a sun-zone) separated by a common interior wall (Figure 5).

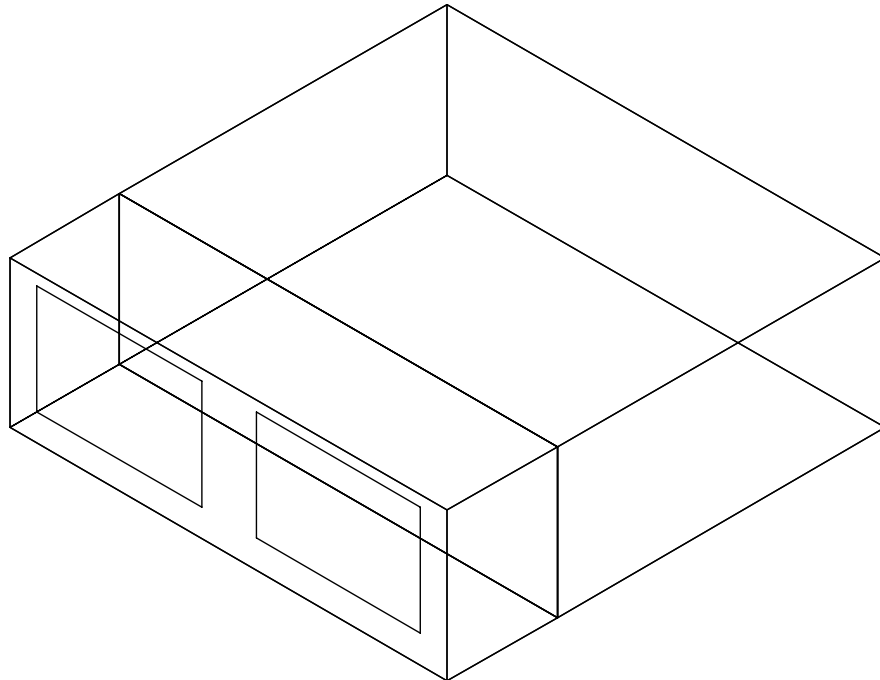

**Figure 5 Sunspace Building with Back-Zone and Sun-Zone (Case 960) - Isometric View of Southeast Corner**

**Back Zone:** The geometric and thermal properties of the back-zone are exactly the same as for Case 600 except that the south wall and windows are replaced with the common wall. Infiltration and internal load in the back-zone is also the same as in Case 600.

**Common Wall:** Material properties of the common wall are as follows:

Element	k (W/m-K)	Thickness (m)	U (W/m <sup>2</sup> -K)	R (m <sup>2</sup> -K/W)	Density (kg/m <sup>3</sup> )	Cp (J/kg-K)
Common Wall	0.510	0.200	2.55	0.392	1400	1000

**Sun-Zone:** The sun-zone is 2 m deep by 8 m wide by 2.7 m high. The back (north) wall of the sun-zone is the common wall. The south wall of the sun-zone contains two 6 m<sup>2</sup> windows that are identical to the windows in Case 900 except that they are raised to a level of 0.5 m above the ground. The thermal and physical properties of the sun-zone are the same as case 900 with the following exceptions:

- a) Zone depth is 2 meters.
- b) The north wall has been replaced with the common wall.
- c) The east and west walls (end-walls) are 5.4 m<sup>2</sup> each.
- d) The volume of the sun-zone is 43.2 m<sup>3</sup>.
- e) Infiltration rate is 0.5 air changes per hour.
- f) Internal heat gain = 0 W.
- g) Heating and cooling control strategy as follows:  
 Sun-zone has no space conditioning system (free floating).  
 Back-zone is controlled the same as for case 600.

#### ***1.2.14 Case 600FF – Free Floating Temperature Test for Base Case Low Mass Building***

Case 600FF is the same as Case 600 except that there is no mechanical heating or cooling system.

#### ***1.2.15 Case 650FF – Free Floating Temperature Test for Base Case Low Mass Building with Night Ventilation***

Case 650FF is the same as Case 650 except that there is no mechanical heating or cooling system.



### ***1.2.16 Case 900FF – Free Floating Temperature Test for Base Case High Mass Building***

Case 900FF is the same as Case 900 except that there is no mechanical heating or cooling system.

### ***1.2.17 Case 950FF – Free Floating Temperature Test for Base Case High Mass Building with Night Ventilation***

Case 950FF is the same as Case 950 except that there is no mechanical heating or cooling system.

### ***1.2.18 Case 195 – Indepth Test of Solid Conduction Problem for Low Mass Building***

Case 195 is the same as case 600 with the following exceptions:

- a) South wall contains no windows and is entirely constructed of the Lightweight mass exterior wall construction described in Section 1.2.1.
- b) Infiltration Rate = 0
- c) Internal Gains = 0
- d) Thermostat control is “20,20 bang-bang”  
Heat = on if temperature < 20C  
Cool = on if temperature > 20C
- e) Interior and exterior surface emissivity and absorptance set = 0.1

## **1.3 Modeling Notes**

The specifications as presented in Section 5 - Test Procedures of ANSI/ASHRAE Standard 140-2001 were followed to prepare the EnergyPlus models for the test cases described above. In some cases the specification provided redundant input values for a particular element of the building due to the fact different programs require different inputs. The following notes are presented regarding preparation of EnergyPlus IDF files:

- a) The weather file used for all simulations was taken from a disk that was provided along with the IEA Building Energy Simulation Test (BESTEST) and Diagnostic Method report dated February 1995. The hourly weather is for the Denver, Colorado (39.8° latitude, 104.9° west longitude) and is characterized as “cold clear winters/hot dry summers.”
- b) Although the specification spelled out in detail the exterior and interior radiative and convective surface properties, these were not used. The specification indicated that if

your program automatically calculates the exterior and interior film coefficients, then these radiative and convective input values were to be disregarded.

- c) The material layers for walls, floors and roofs were specified using the MATERIAL:Regular object except for the floor insulation which was described using the MATERIAL:Regular-R object. The opaque surface radiative properties listed in the MATERIAL object were defined in the specification and were set as follows:

Thermal Emissivity	0.90
Solar Absorptance	0.60
Visible Absorptance	0.60
  
- d) The glass for windows was specified using the MATERIAL:WINDOWGLASS and MATERIAL:WINDOWGAS objects. Certain input variables listed in the MATERIAL:WINDOWGLASS object were not defined in the specification and were set as follows:

Visible Transmittance (set equal to Solar Transmittance)	0.86156
--	---------
  
- e) The convergence variables in the BUILDING object were set as follows:

Loads Convergence Tolerance	3.9999999E-02
Temperature Convergence Tolerance	4.0000002E-03
  
- f) To get the shade calculations to work for the window overhang test cases, the following variables in the BUILDING object had to be set:

SOLAR DISTRIBUTION = FullInteriorAndExterior

Same was true for cases with window fins.
  
- g) The following objects were set to:

INSIDE CONVECTION ALGORITHM = Detailed

OUTSIDE CONVECTION ALGORITHM = Detailed
  
- h) To get the dual setpoint with deadband thermostat (Type=4) to work, the following object had to be specified:

ZONE VOLUME CAPACITANCE MULTIPLIER = 1
  
- i) The PURCHASED AIR system was used to model the mechanical system.
  
- j) All simulations were done using a TIMESTEP = 4; output results were reported hourly.

## 2 RESULTS AND DISCUSSION

The results of the EnergyPlus Loads comparison with other whole building energy analysis programs that participated in the BESTEST Comparison are summarized on a set of charts presented in Appendix A. The nomenclature for the various programs referred to on these charts along with the program author and modeler responsible for using the program as part of the BESTEST project are presented below. Results for later versions of BLAST (3.0 level 334) and DOE2 (2.1E) which were not part of the BESTEST exercise have also been added.

Code Name	Computer Program	Developer	Implemented by
BLAST	BLAST-3.0 level 193 v.1	CERL, U.S.	NREL, U.S. Politecnico, Torino, Italy
DOE2	DOE2.1D 14	LANL/LBL, U.S.	NREL, U.S.
ESP	ESP-RV8	Strathclyde University, U.K.	De Montfort University, U.K.
SRES/SUN	SERIRES/SUNCODE 5.7	NREL/Ecotope, U.S.	NREL, U.S.
SERIRES	SERIRES 1.2	NREL, U.S. BRE, U.K.	BRE, U.K.
S3PAS	S3PAS	University of Sevilla, Spain	University of Sevilla, Spain
TASE	TASE	Tampere University, Finland	Tampere University, Finland
TRNSYS	TRNSYS 13.1	University of Wisconsin, U.S.	BRE, U.K. Vrije Universiteit (VUB), Brussels, Belgium
DOE2	DOE2.1E	LANL/LBL, U.S.	GARD Analytics, U.S. using NREL input files
BLAST	BLAST-3.0 level 334	CERL, U.S.	GARD Analytics, U.S. using NREL input files
ENERGYPLUS	EnergyPlus ver. 1.2.0.029, May. 2004	U.S. Dept. of Energy	GARD Analytics, U.S.

Appendix A contains a series of charts that compare the results of EnergyPlus with other programs. The charts are presented in the following order:

- Low Mass Building, Annual Heating, Cases 600, 610, 620, 630, 640, 650
- Low Mass Building, Annual Cooling, Cases 600, 610, 620, 630, 640, 650
- Low Mass Building, Peak Heating, Cases 600, 610, 620, 630, 640, 650
- Low Mass Building, Peak Cooling, Cases 600, 610, 620, 630, 640, 650
- High Mass Building, Annual Heating, Cases 900, 910, 920, 930, 940, 950, 960
- High Mass Building, Annual Cooling, Cases 900, 910, 920, 930, 940, 950, 960
- High Mass Building, Peak Heating, Cases 900, 910, 920, 930, 940, 950, 960
- High Mass Building, Peak Cooling, Cases 900, 910, 920, 930, 940, 950, 960
- Free Floating Zone Temperature, Maximum Temperature, Cases 600FF, 900FF, 650FF, 950FF, 960 Sunspace
- Free Floating Zone Temperature, Minimum Temperature, Cases 600FF, 900FF, 650FF, 950FF, 960 Sunspace
- Low Mass Building, Low Absorptances, No Windows, Case 195.

Results are also summarized in tabular format in Appendix B.

One measure of comparison as to how well EnergyPlus predicted thermal loads compared to the other programs is to see if the results fall within the range of spread of results for other programs. This can be seen visually with the charts included in Appendix A where the annual heating, annual cooling, peak heating and peak cooling are displayed as a series of bars for the series 600 and series 900 cases that were analyzed by all programs. Appendix B shows the same results but in tabular format and also includes a row for each comparison indicating a YES or NO if EnergyPlus was within range. For the 52 individual comparisons that were performed, the EnergyPlus results were within the range of spread of results for the other programs for all cases except the following:

Test	Building Type	Feature Being Tested	Output Parameter	Range of Other Programs	EnergyPlus
640	Low Mass	Thermostat Setback	Peak Heating	5.23 to 6.95	7.34
930	High Mass	East/West Windows with Shading	Annual Heating	4.14 to 5.34	4.05

For the free floating cases where 10 additional comparisons were made, the maximum and minimum zone temperatures predicted by EnergyPlus were within the range of spread for all the programs except for:

Test	Building Type	Feature Being Tested	Output Parameter	Range of Other Programs	EnergyPlus
650FF	Low Mass	Night Ventilation	Minimum Zone Temp.	-23.0 to -21.0	-23.1
950FF	High Mass	Night Ventilation	Minimum Zone Temp.	-20.2 to -17.8	-20.4

For the solid conduction problem (case 195) it was not possible to make a broad comparison since there was only one program recognized by ASHRAE as having a valid result.

A series of “Delta Charts” were also generated which compare the difference in results between certain cases in order to isolate the sensitivity of each program to changes in building features such as mass construction, addition of windows with and without shading, thermostat setback, ventilation cooling, etc. The “Delta Charts” comparing EnergyPlus results with other programs are presented in Appendix C. A visual comparison of EnergyPlus results compared to other programs indicates significant difference for:

Delta Test	Building Type	Feature Being Tested	Output Parameter	Range of Other Programs	EnergyPlus
(640 – 600)	Low Mass	Setback vs. No Setback	Peak Heating	1.55 to 2.60	3.50
(650 – 600)	Low Mass	Vent Cooling vs. No Vent Cooling	Annual Cooling	-1.42 to -1.24	-1.65
(920 – 900)	High Mass	E/W Window vs. S Window	Annual Cooling	-0.356 to 0.018	0.086

Further EnergyPlus testing will be done to determine the reasons for these differences.

## 2.1 Comparison of Changes that Occurred Between Versions of EnergyPlus

This section documents the comparative changes that took place in results as modifications were made to the EnergyPlus code or changes were made in the modeling approach. Since the first reporting of EnergyPlus results for BESTEST with version 1.0.0.023 back in August 2001, further capabilities and improvements have been added to EnergyPlus with new releases in June 2002 (version 1.0.1), August 2002 (version 1.0.2), December 2002 (version 1.0.3), April 2003 (version 1.1.0), September 2003 (version 1.1.1) and May 2004 (version 1.2.0). The table below summarizes pertinent input file and code changes that were made as the testing progressed with each new public release of EnergyPlus.

### Summary of Pertinent EnergyPlus Changes that were Implemented Since Original Testing with Version 1.0.0.023

Version	Input File Changes	Code Changes
1.0.1.001		Change in weather processing file
1.0.1.008		Change in solar position calculation
1.0.1.037		Added ability to input monthly ground reflectance
1.0.1.040	Set monthly ground reflectance to 0.20. Previously defaulted to 0.2 – 0.6 depending on month	
1.0.1.026	Set SHADOW CALCULATIONS = 1; previously defaulted to 20	
1.0.3.006		Changed weather interpolation to previous hour
1.0.3.015		Changed to “half” interpolation for solar radiation
1.1.1.004		Changed surface convection coefficient algorithms
1.2.0		More changes to exterior convection coefficient algorithms

Charts presented in Appendix D show graphically how results changed for the various BESTEST cases with the seven public release versions of EnergyPlus and changes discussed in the above table. Changes in results between the first two releases were sometimes significant (as high as 10%). Some significant changes also occurred with version 1.1.1.004 where surface convection coefficient algorithms were changed.

### 3 CONCLUSIONS

---

EnergyPlus Version 1.2.0.029 was used to model a range of building specifications as specified in ANSI/ASHRAE Standard 140-2001 - *Standard Method of Test for the Evaluation of Building Energy Analysis Computer Programs* and in the *Building Energy Simulation Test (BESTEST) and Diagnostic Method*. The ability of EnergyPlus to predict thermal loads was tested using a test suite of 18 cases which included buildings with both low mass and high mass construction, without windows and with windows on various exposures, with and without exterior window shading, with and without temperature setback, with and without night ventilation, and with and without free floating space temperatures. The annual heating and cooling and peak heating and cooling results predicted by EnergyPlus for 13 different cases were compared to results from 8 other whole building energy simulation programs that participated in an International Energy Agency (IEA) project conducted in February 1995. Maximum and minimum free-floating temperatures were compared for 4 different cases. A solid conduction case was compared to only one other program due to modeling limitations in the other programs. Based on 62 separate possible comparisons of results, EnergyPlus was within the range of spread of results for the other 8 programs for 58 of the comparisons. The four cases outside of range were all less than 5.6% out of bounds.





## 4 REFERENCES

---

ANSI/ASHRAE 2001. Standard 140-2001, Standard Method of Test for the Evaluation of Building Energy Analysis Computer Programs.

EnergyPlus 2004. U.S. Department of Energy, Energy Efficiency and Renewable Energy, Office of Building Technologies. [www.energyplus.gov](http://www.energyplus.gov)

IEA 1995. *Building Energy Simulation Test (BESTEST) and Diagnostic Method*, National Renewable Energy Laboratory, Golden, Colorado, February 1995.



## **Appendix A**

### **Charts Comparing EnergyPlus Results with Other Whole Building Energy Simulation Programs**



# BESTEST Comparison (Denver, dry/cold)

## Low Mass Building Annual Heating

EnergyPlus Version 1.2.0, Build 029, 5/6/04

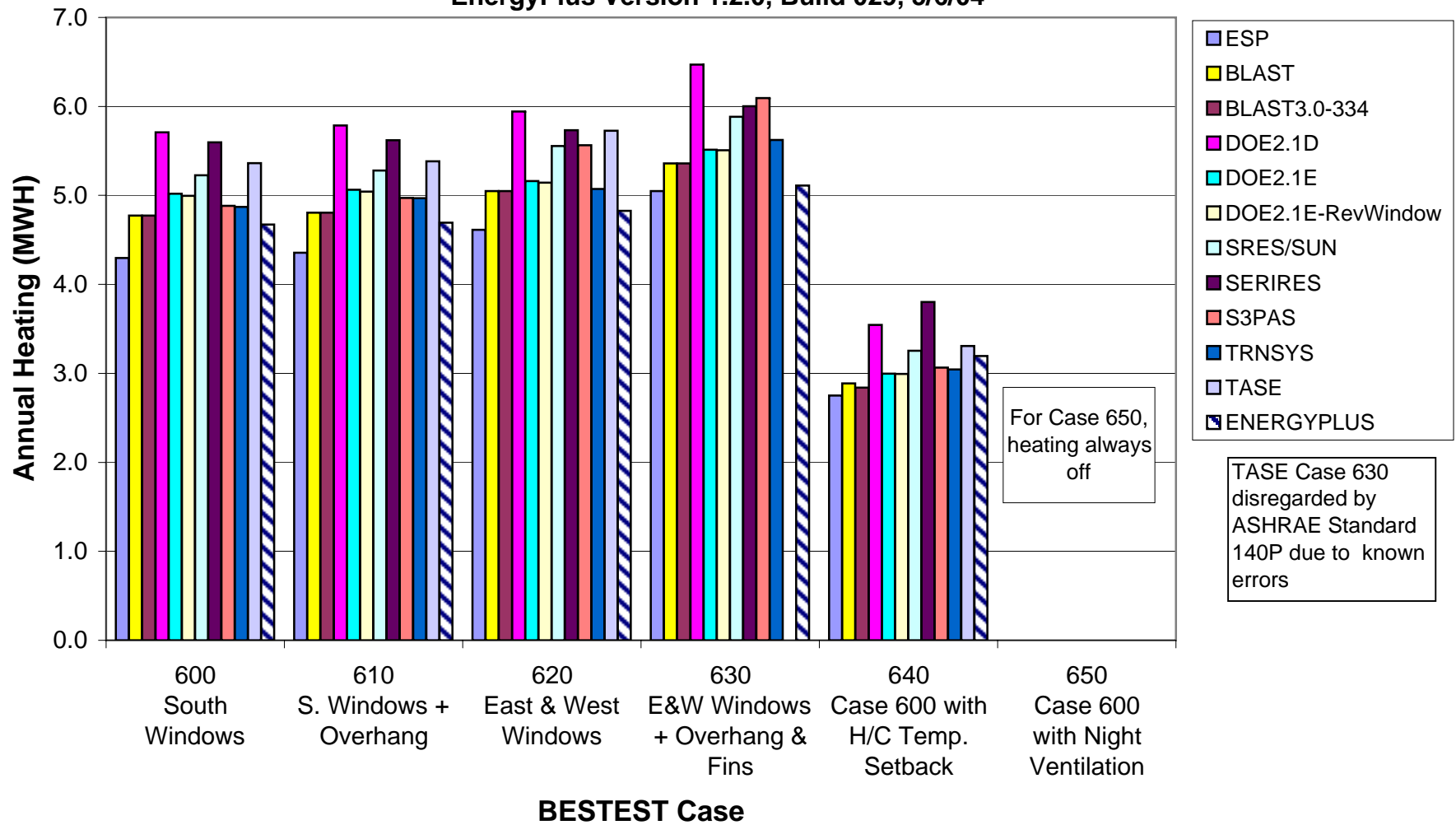

# BESTEST Comparison (Denver, dry/cold) Low Mass Building Annual Cooling

EnergyPlus Version 1.2.0, Build 029, 5/6/04

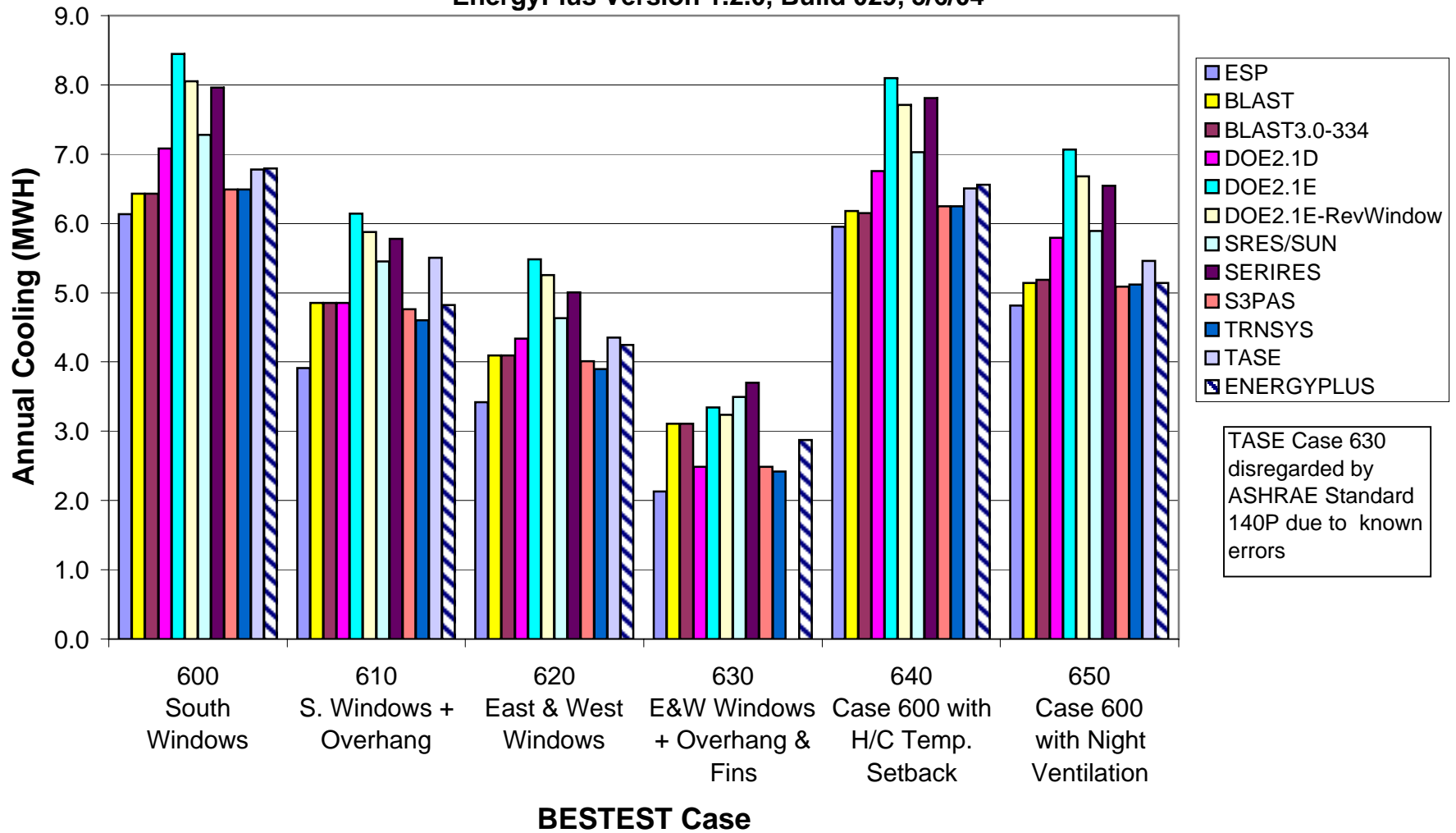

# BESTEST Comparison (Denver, dry/cold) Low Mass Building Peak Heating

EnergyPlus Version 1.2.0, Build 029, 5/6/04

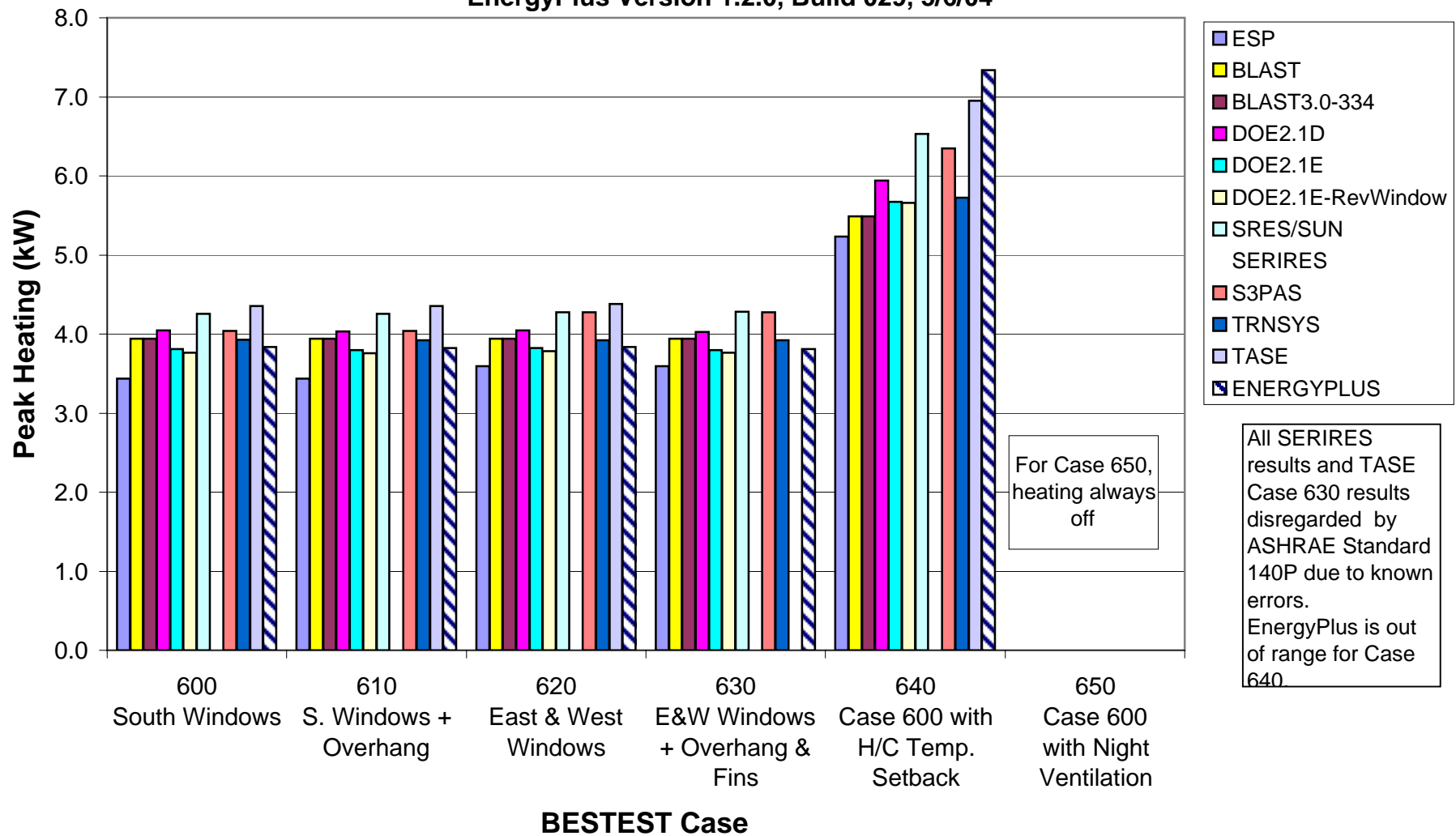

# BESTEST Comparison (Denver, dry/cold) Low Mass Building Peak Cooling

EnergyPlus Version 1.2.0, Build 029, 5/6/04

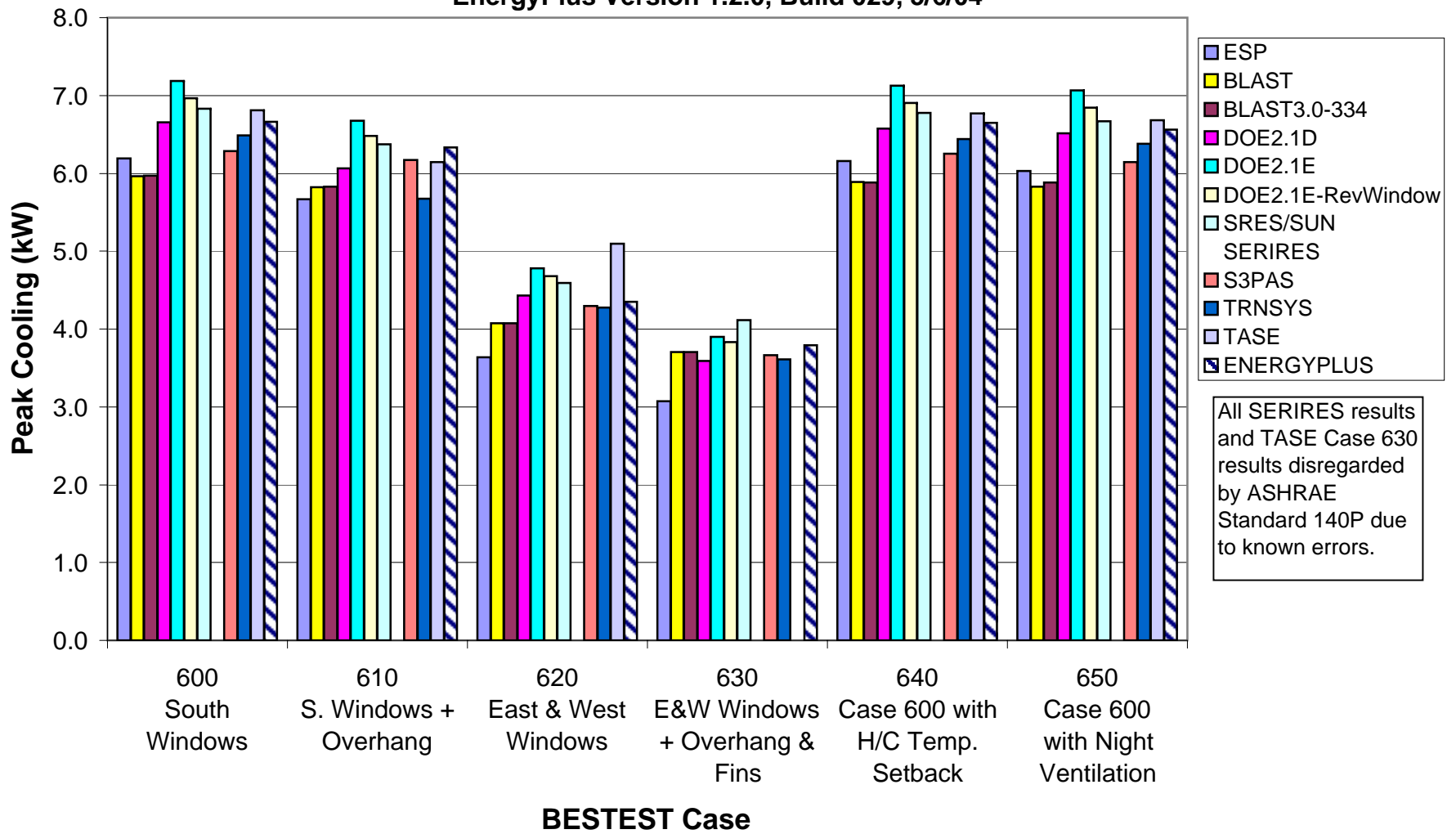



# BESTEST Comparison (Denver, dry/cold) High Mass Building Annual Heating

EnergyPlus Version 1.2.0, Build 029, 5/6/04

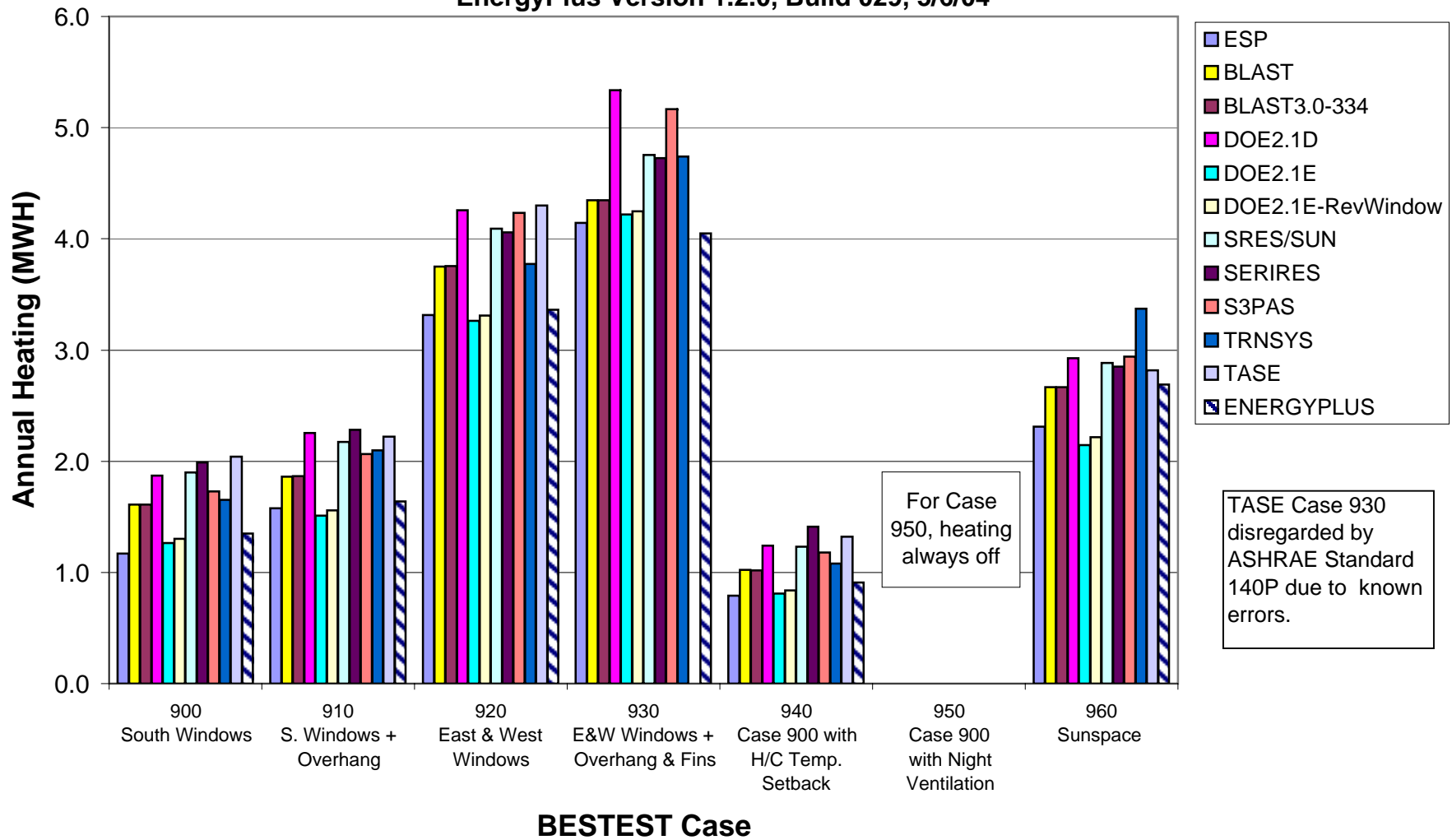

# BESTEST Comparison (Denver, dry/cold) High Mass Building Annual Cooling

EnergyPlus Version 1.2.0, Build 029, 5/6/04

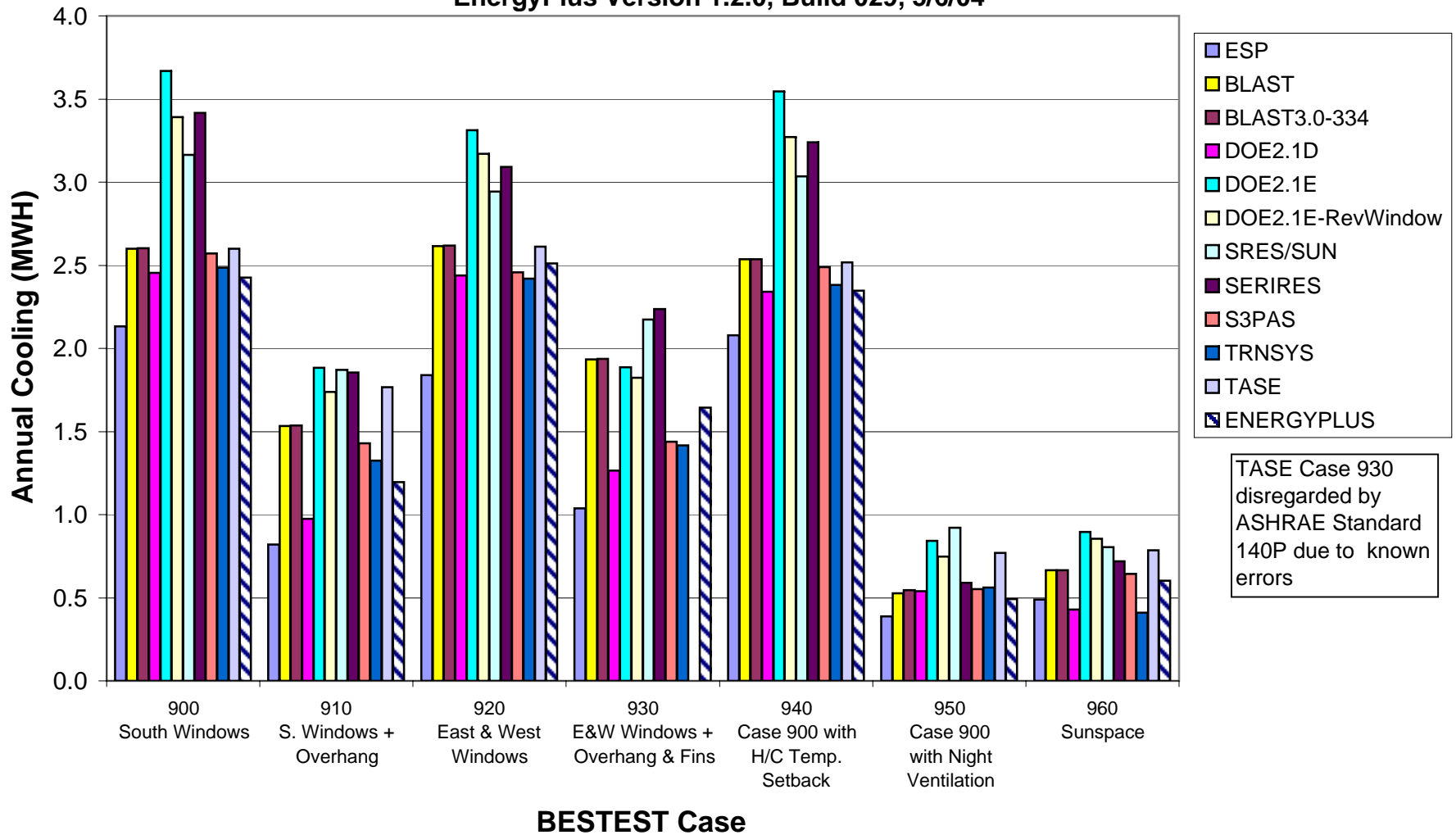

# BESTEST Comparison (Denver, dry/cold) High Mass Building Peak Heating

EnergyPlus Version 1.2.0, Build 029, 5/6/04

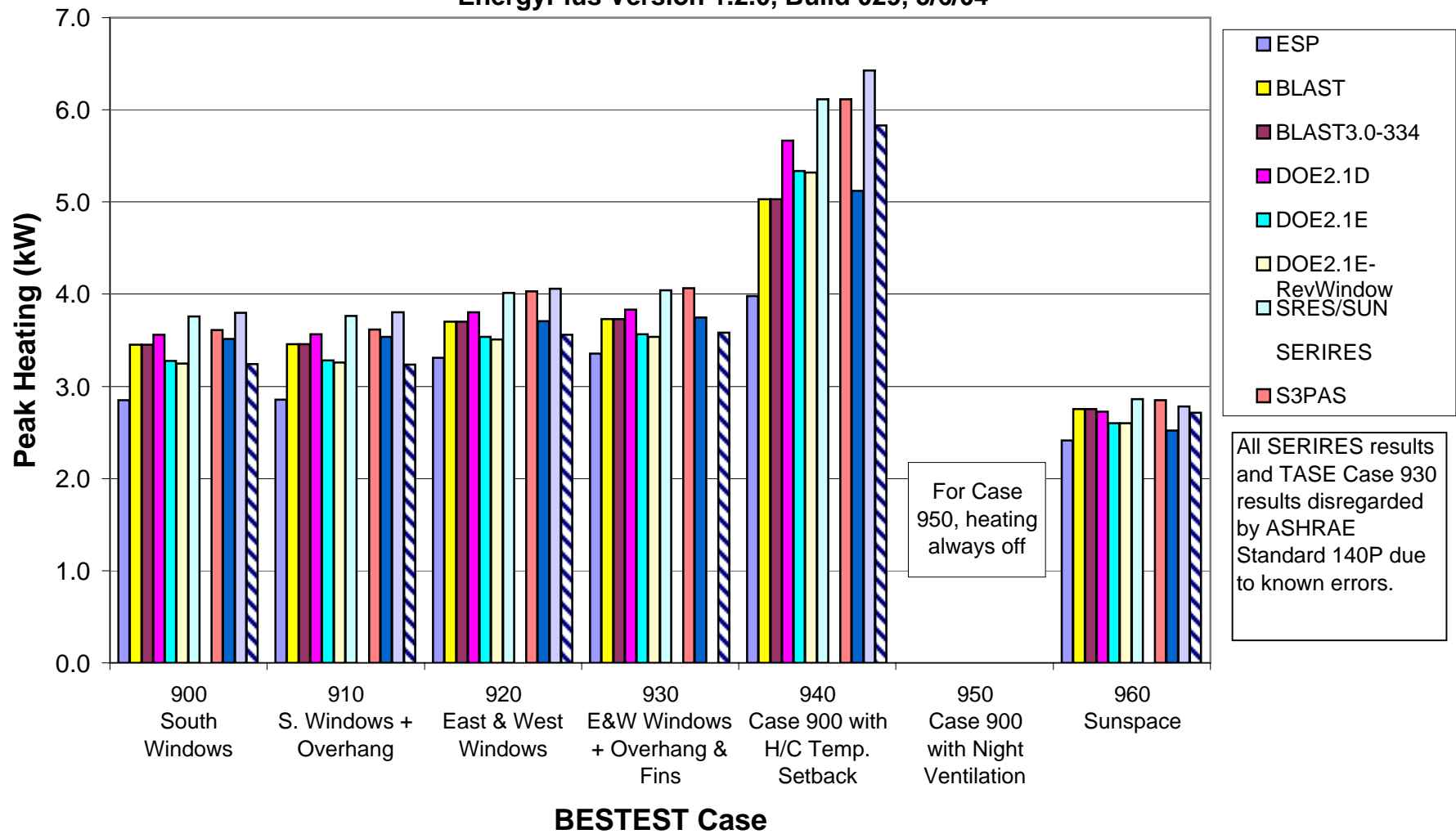

# BESTEST Comparison (Denver, dry/cold) High Mass Building Peak Cooling

EnergyPlus Version 1.2.0, Build 029, 5/6/04

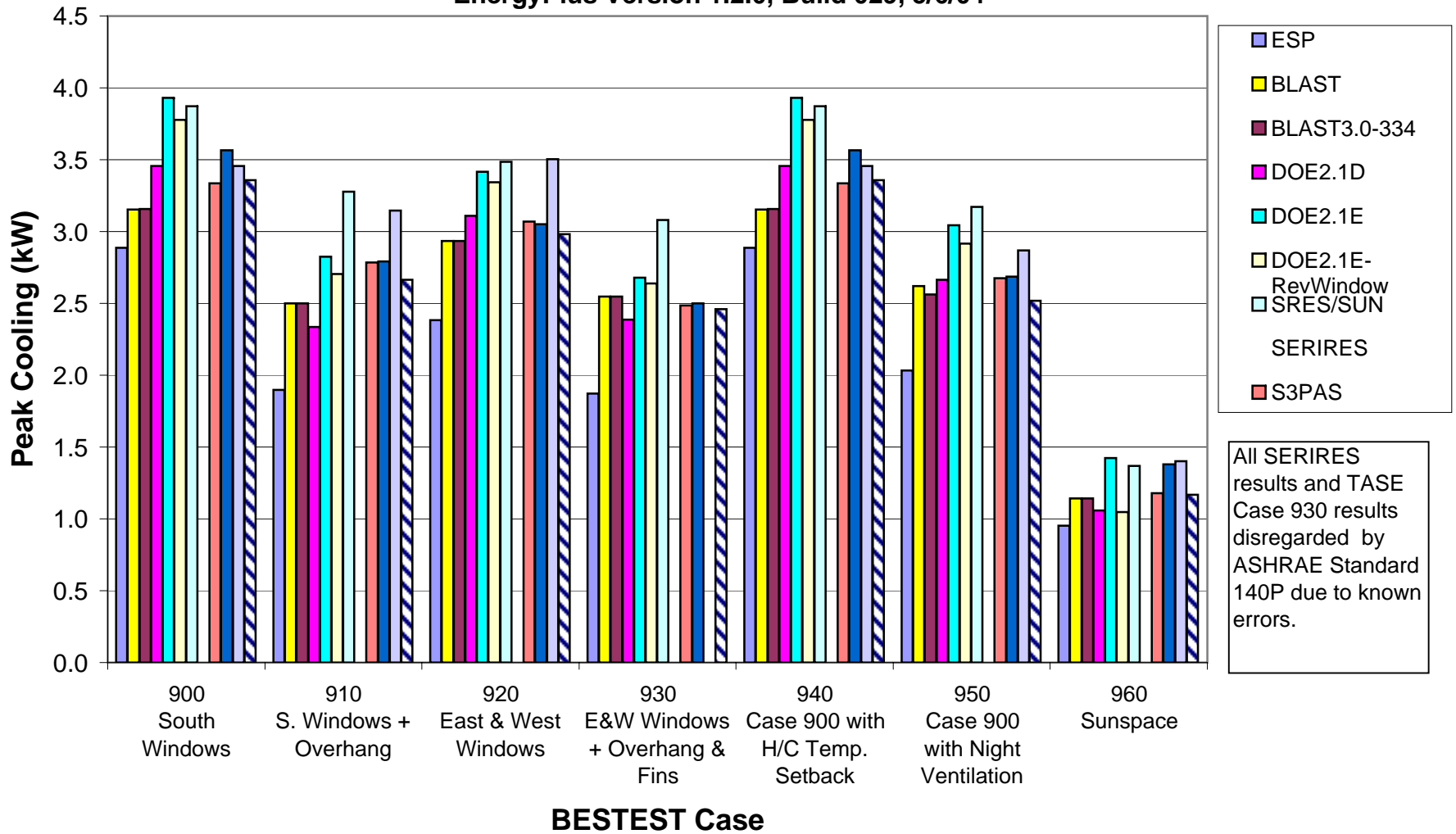

# BESTEST Comparison (Denver, dry/cold) Free Floating Maximum Temperature

EnergyPlus Version 1.2.0, Build 029, 5/6/04

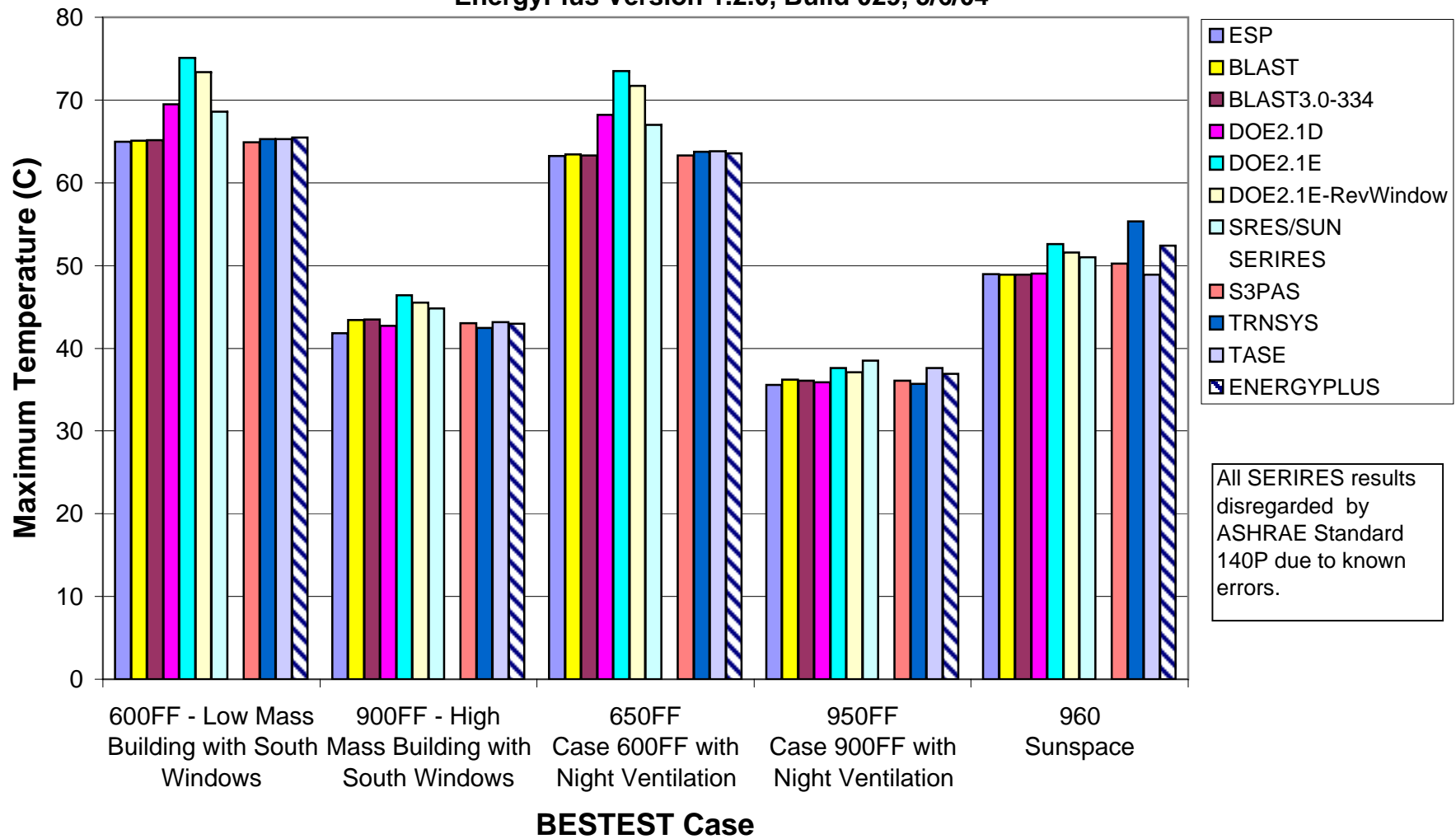

# BESTEST Comparison (Denver, dry/cold) Free Floating Minimum Temperature

EnergyPlus Version 1.2.0, Build 029, 5/6/04

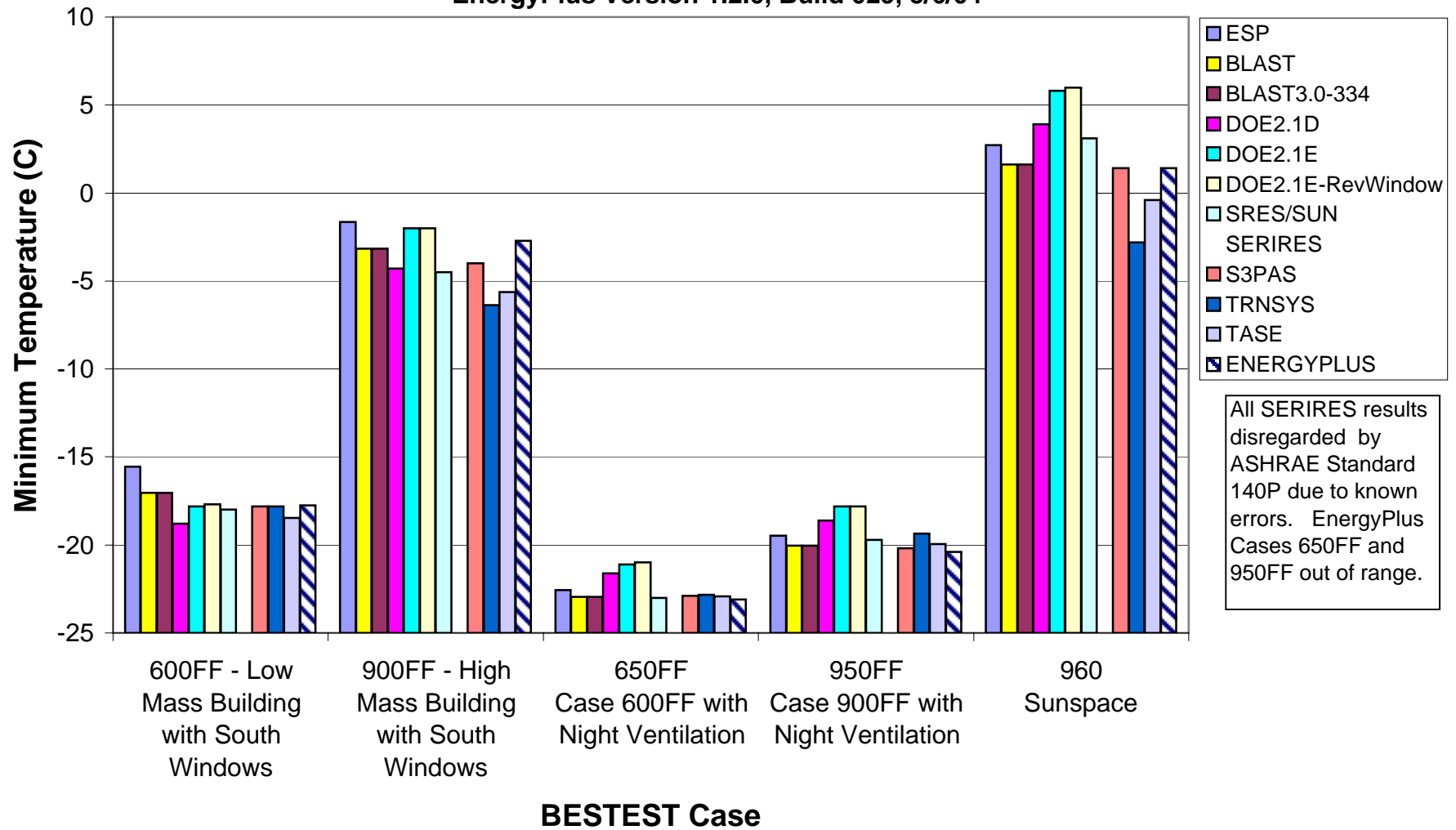

# BESTEST Comparison (Denver, dry/cold)

## Low Mass Building (low absorptances, no windows)

EnergyPlus Version 1.2.0, Build 029, 5/6/04

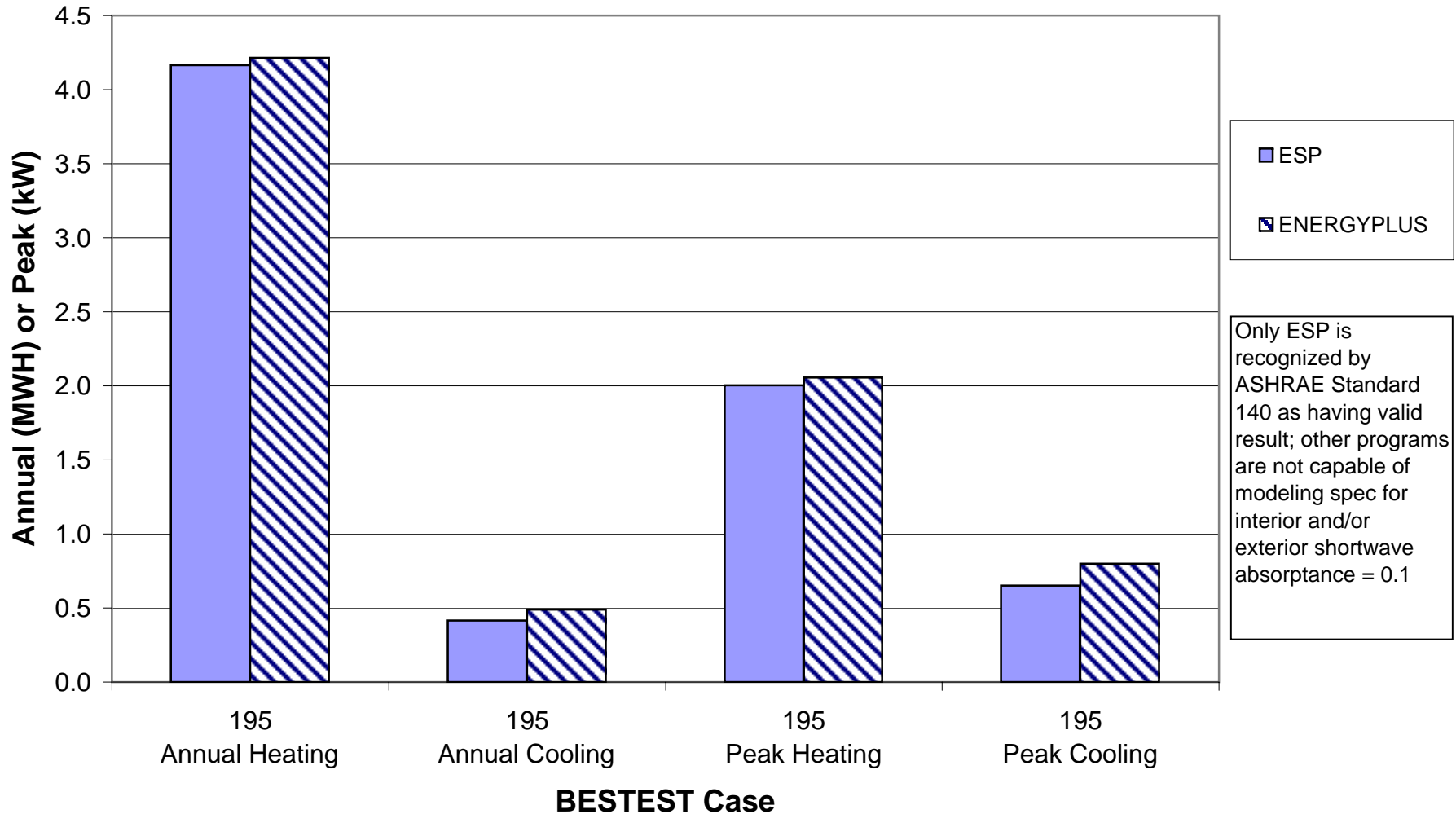





## **Appendix B**

### **Tables Comparing EnergyPlus Results with Other Whole Building Energy Simulation Programs**



## Comparison Of EnergyPlus Results with BESTEST

Using EnergyPlus Version 120, Build 29, 5/6/04, Exterior Convection Coefficient & Window Transmittance calculations changed in 111-09

BESTEST Min, Max, Average values conform with ASHRAE Standard 140P  
and also include results for DOE-2.1E and BLAST 3.0-334

### Low Mass Building

BESTEST Case	600	610	620	630	640	650
<b>Description</b>	<b>Basic Heat Transfer Problem</b> Windows on South wall 200 w internal load 0.5 ACH infiltration H/C Setpoint 20C/27C	<b>South Shade Problem</b> Same as 600 with 1.0M overhang on South Wall	<b>East/West Incid./Trans. Problem</b> Windows on East & West wall 200 w internal load 0.5 ACH infiltration H/C Setpoint 20C/27C	<b>East/West Shade Problem</b> Same as 620 with 1.0M overhang & fins on windows from roof to ground	<b>Setback Problem</b> Same as 600 Setback Thermostat Cooling 27C, all hours Heating 10C, 2300 to 0700 Heating 20C, 0700 to 2300	<b>Night Ventilation Problem</b> Same as 600 Vent air 1800-700 hrs Cooling 27C, 700-1800 hrs Heating, always off
<b>Annual Heating (MWh)</b>						
BESTEST Minimum	4.296	4.355	4.613	5.050	2.751	0
BESTEST Maximum	5.709	5.786	5.944	6.469	3.803	0.000
BESTEST Average	5.046	5.098364	5.328	5.686	3.135	0.000
E-Plus	4.673	4.693	4.828	5.112	3.195	0.000
Difference, %	-7.4%	-7.9%	-9.4%	-10.1%	1.9%	-100.0%
EnergyPlus Within Range	YES	YES	YES	YES	YES	YES
<b>Annual Cooling (MWh)</b>						
BESTEST Minimum	6.137	3.915	3.417	2.129	5.952	4.816
BESTEST Maximum	8.448	6.139	5.482	3.701	8.097	7.064
BESTEST Average	7.053	5.144	4.416	2.951	6.790	5.708
E-Plus	6.792	4.821	4.249	2.875	6.558	5.139
Difference, %	-3.7%	-6.3%	-3.8%	-2.6%	-3.4%	-10.0%
EnergyPlus Within Range	YES	YES	YES	YES	YES	YES
<b>Peak Heating (KW)</b>						
BESTEST Minimum	3.437	3.437	3.591	3.592	5.232	0
BESTEST Maximum	4.354	4.354	4.379	4.28	6.954	0
BESTEST Average	3.952	3.947	3.998	3.949	5.903	0.000
E-Plus	3.838	3.824	3.835	3.809	7.339	0.000
Difference, %	-2.9%	-3.1%	-4.1%	-3.5%	24.3%	#DIV/0!
EnergyPlus Within Range	YES	YES	YES	YES	NO	YES
<b>Peak Cooling (KW)</b>						
BESTEST Minimum	5.965	5.669	3.634	3.072	5.884	5.831
BESTEST Maximum	7.188	6.673	5.096	4.116	7.126	7.068
BESTEST Average	6.535	6.090	4.393	3.688	6.478	6.404
E-Plus	6.664	6.334	4.352	3.791	6.650	6.563
Difference, %	2.0%	4.0%	-1.0%	2.8%	2.7%	2.5%
EnergyPlus Within Range	YES	YES	YES	YES	YES	YES

## Comparison Of EnergyPlus Results with BESTEST

Using EnergyPlus Version 120, Build 29, 5/6/04, Exterior Convection Coefficient & Window Transmittance calculations changed in 111-09

BESTEST Min, Max, Average values conform with ASHRAE Standard 140P  
and also include results for DOE-2.1E and BLAST 3.0-334

### High Mass Building

BESTEST Case	900	910	920	930	940	960	950
<b>Description</b>	<b>Basic Heat Transfer Problem</b> Windows on South wall 200 w internal load 0.5 ACH infiltration H/C Setpoint 20C/27C	<b>South Shade Problem</b> Same as 900 with 1.0M overhang on South Wall	<b>East/West Incid./Trans. Problem</b> Windows on East & West wall 200 w internal load 0.5 ACH infiltration H/C Setpoint 20C/27C	<b>East/West Shade Problem</b> Same as 920 with 1.0M overhang & fins on windows from roof to ground	<b>Setback Problem</b> Same as 900 Setback Thermostat Cooling 27C, all hours Heating 10C, 2300 to 0700 Heating 20C, 0700 to 2300	<b>Passive Solar Problem</b> Same as 900 but with sunspace and interior wall Sunspace is uncontrolled and has two windows	<b>Night Ventilation Problem</b> Same as 900 Vent air 1800-700 hrs Cooling 27C, 700-1800 hrs Heating, always off
<b>Annual Heating (MWh)</b>							
BESTEST Minimum	1.170	1.512	3.261	4.143	0.793	2.144	0
BESTEST Maximum	2.041	2.282	4.300	5.335	1.411	3.373	7.801E-06
BESTEST Average	1.649	1.951	3.828	4.603	1.086	2.709	0.000
E-Plus	1.350	1.636	3.360	4.050	0.911	2.692	0.000
Difference, %	-18.1%	-16.1%	-12.2%	-12.0%	-16.1%	-0.6%	-100.0%
EnergyPlus Within Range	YES	YES	YES	NO	YES	YES	YES
<b>Annual Cooling (MWh)</b>							
BESTEST Minimum	2.132	0.821	1.840	1.039	2.079	0.4113	0.387
BESTEST Maximum	3.669	1.883	3.313	2.238	3.546	0.895	0.921
BESTEST Average	2.826	1.521	2.684	1.715	2.725	0.669	0.635
E-Plus	2.424	1.196	2.510	1.643	2.347	0.604	0.492
Difference, %	-14.2%	-21.4%	-6.5%	-4.2%	-13.9%	-9.7%	-22.5%
EnergyPlus Within Range	YES	YES	YES	YES	YES	YES	YES
<b>Peak Heating (KW)</b>							
BESTEST Minimum	2.850	2.858	3.308	3.355	3.980	2.410	0.000
BESTEST Maximum	3.797	3.801	4.061	4.064	6.428	2.863	0
BESTEST Average	3.452	3.459	3.738	3.733	5.414	2.686	0.000
E-Plus	3.240	3.238	3.559	3.580	5.832	2.716	0.000
Difference, %	-6.1%	-6.4%	-4.8%	-4.1%	7.7%	1.1%	#DIV/0!
EnergyPlus Within Range	YES	YES	YES	YES	YES	YES	YES
<b>Peak Cooling (KW)</b>							
BESTEST Minimum	2.888	1.896	2.385	1.873	2.888	0.953	2.033
BESTEST Maximum	3.932	3.277	3.505	3.080	3.932	1.422	3.17
BESTEST Average	3.460	2.676	3.123	2.526	3.460	1.210	2.724
E-Plus	3.359	2.663	2.981	2.460	3.359	1.169	2.520
Difference, %	-2.9%	-0.5%	-4.5%	-2.6%	-2.9%	-3.4%	-7.5%
EnergyPlus Within Range	YES	YES	YES	YES	YES	YES	YES

## Comparison Of EnergyPlus Results with BESTEST

Using EnergyPlus Version 120, Build 29, 5/6/04, Exterior Convection Coefficient & Window Transmittance calculations changed in 111-09

BESTEST Min, Max, Average values conform with ASHRAE Standard 140P  
and also include results for DOE-2.1E and BLAST 3.0-334

### Free Floating Zone Temperature

BESTEST Case	600FF	900FF	650FF	950FF	960
<b>Description</b>	<b>Basic Heat Transfer Problem Low Mass Building</b> Windows on South wall 200 w internal load 0.5 ACH infiltration Free Float Temperature	<b>Basic Heat Transfer Problem High Mass Building</b> Windows on South wall 200 w internal load 0.5 ACH infiltration Free Float Temperature	<b>Basic Heat Transfer Problem Low Mass Building</b> Windows on South wall 200 w internal load 0.5 ACH infiltration Vent Air 1703.16 m3/h 1800-700 † Free Float Temperature	<b>Basic Heat Transfer Problem High Mass Building</b> Windows on South wall 200 w internal load 0.5 ACH infiltration Vent Air 1703.16 m3/h 1800-700 † Free Float Temperature	<b>Passive Solar Problem</b> Same as 900 but with sunspace and interior wall Sunspace is uncontrolled and has two windows
<b>Maximum Annual Hourly Zone Temperature (C)</b>					
BESTEST Minimum	64.9	41.8	63.2	35.5	48.9
BESTEST Maximum	75.1	46.4	73.5	38.5	55.34
BESTEST Average	67.7	43.7	66.1	36.6	50.5
E-Plus	65.4	43.0	63.5	36.9	52.4
Difference, %	-3.4%	-1.6%	-3.9%	0.7%	3.7%
EnergyPlus Within Range	YES	YES	YES	YES	YES
<b>Minimum Annual Hourly Zone Temperature (C)</b>					
BESTEST Minimum	-18.8	-6.4	-23.0	-20.2	-2.8
BESTEST Maximum	-15.6	-1.6	-21.0	-17.8	6.0
BESTEST Average	-17.6	-3.7	-22.4	-19.3	2.3
E-Plus	-17.8	-2.7	-23.1	-20.4	1.4
Difference, %	0.9%	-25.8%	3.3%	5.6%	-38.7%
EnergyPlus Within Range	YES	YES	NO	NO	YES
<b>Average Annual Hourly Zone Temperature (C)</b>					
BESTEST Minimum	24.2	24.5	18.0	14.0	26.4
BESTEST Maximum	27.4	27.5	20.8	15.3	30.5
BESTEST Average	25.3	25.5	18.9	14.5	28.2
E-Plus	25.4	25.6	17.9	14.4	28.1
Difference, %	0.4%	0.5%	-5.3%	-0.5%	-0.5%
EnergyPlus Within Range	YES	YES	NO	YES	YES

## Comparison Of EnergyPlus Results with BESTEST

Using EnergyPlus Version 120, Build 29, 5/6/04, Exterior Convection Coefficient & Window Transmittance calculations changed in 111-09

BESTEST Min, Max, Average values conform with ASHRAE Standard 140P; only ESP results shown for this case  
DOE-2.1E and BLAST 30-334 results are not included in BESTEST Min, Max, Average

### Low Mass Building

**BESTEST Case** 195

**Description** **Solid Conduction Problem**  
Rectangular box of low mass construction  
No windows, internal load or infiltration  
Constant 20C setpoint

#### Annual Heating (MWh)

BESTEST Minimum	4.1670
BESTEST Maximum	4.1670
BESTEST Average	4.1670
E-Plus	4.2145
Difference, %	1.1%
EnergyPlus Within Range	NO

#### Annual Cooling (MWh)

BESTEST Minimum	0.4140
BESTEST Maximum	0.4140
BESTEST Average	0.4140
E-Plus	0.4879
Difference, %	17.9%
EnergyPlus Within Range	NO

#### Peak Heating (KW)

BESTEST Minimum	2.0040
BESTEST Maximum	2.0040
BESTEST Average	2.0040
E-Plus	2.0548
Difference, %	2.5%
EnergyPlus Within Range	NO

#### Peak Cooling (KW)

BESTEST Minimum	0.651
BESTEST Maximum	0.651
BESTEST Average	0.651
E-Plus	0.7976
Difference, %	22.5%
EnergyPlus Within Range	NO

## **Appendix C**

### **Delta Charts Comparing EnergyPlus Results with Other Whole Building Energy Simulation Programs**





**BESTEST Comparison (Denver, dry/cold)**  
**South Shaded Window (Delta)**  
**Annual Heating and Cooling**  
 EnergyPlus Version 1.2.0, Build 029, 5/6/04

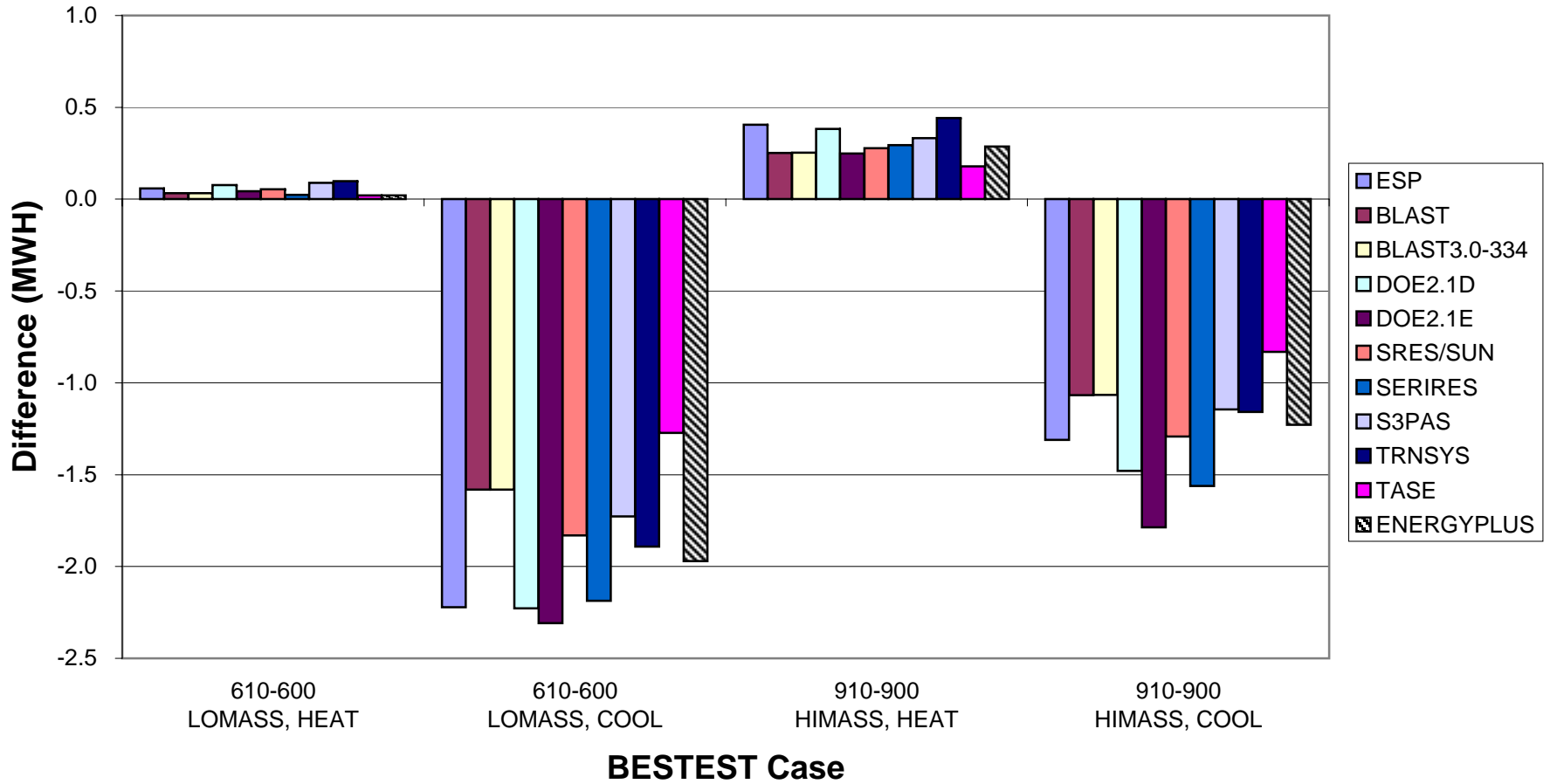

# BESTEST Comparison (Denver, dry/cold)

## South Shaded Window (Delta)

### Peak Heating and Cooling

EnergyPlus Version 1.2.0, Build 029, 5/6/04

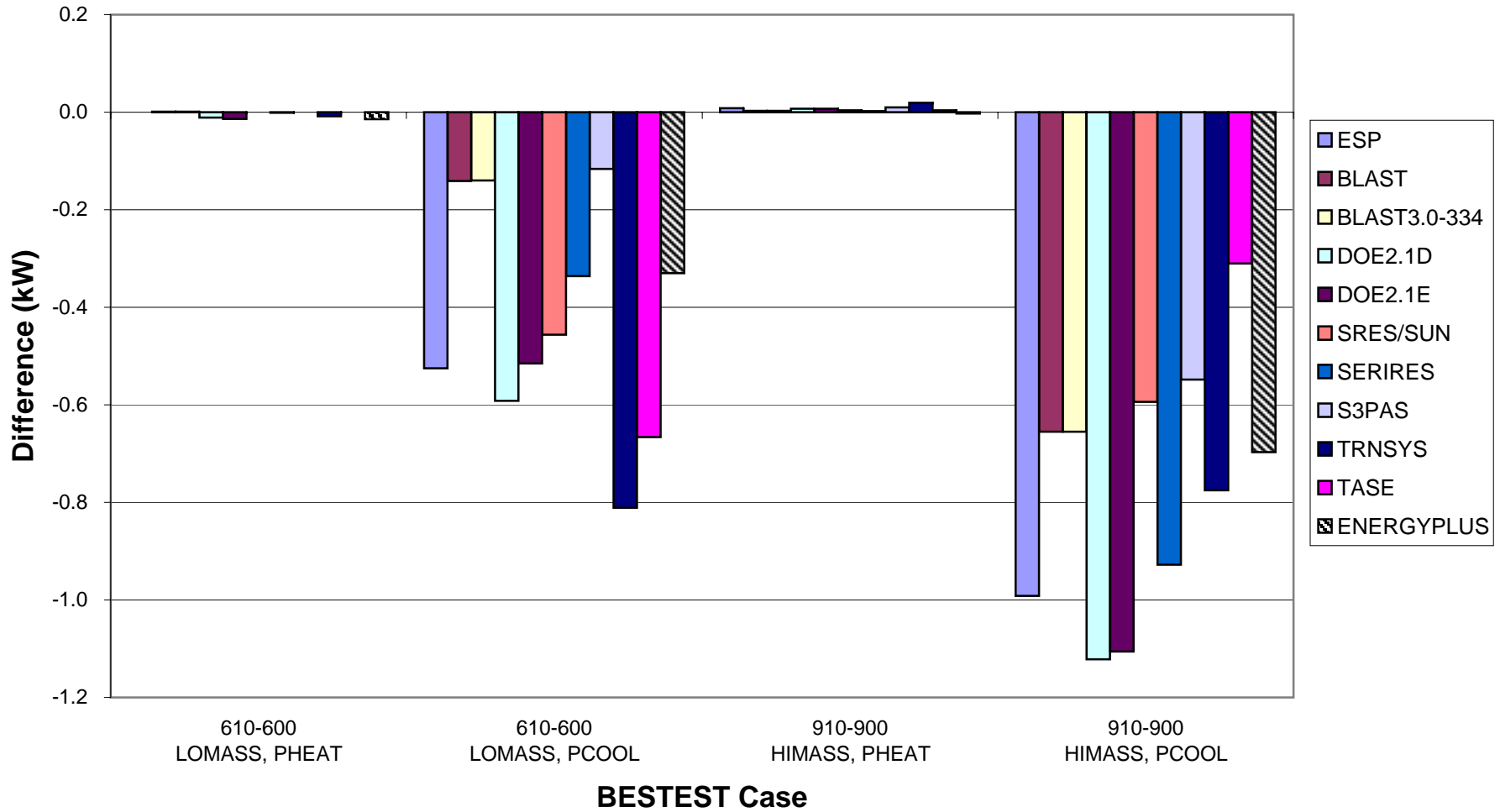

# BESTEST Comparison (Denver, dry/cold)

## East & West Window (Delta)

### Annual Heating and Cooling

EnergyPlus Version 1.2.0, Build 029, 5/6/04

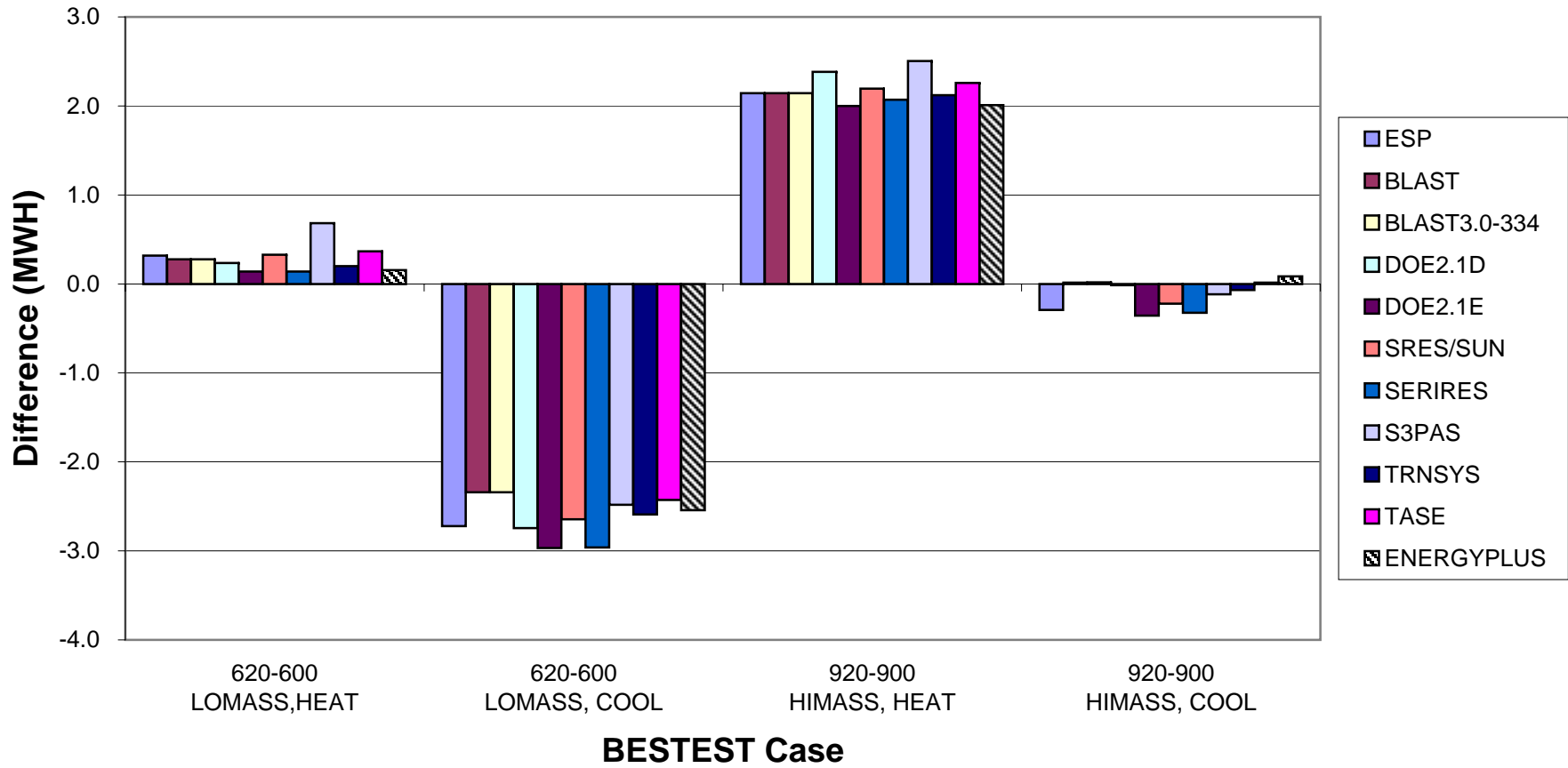

**BESTEST Comparison (Denver, dry/cold)**  
**East & West Window (Delta)**  
**Peak Heating and Cooling**  
 EnergyPlus Version 1.2.0, Build 029, 5/6/04

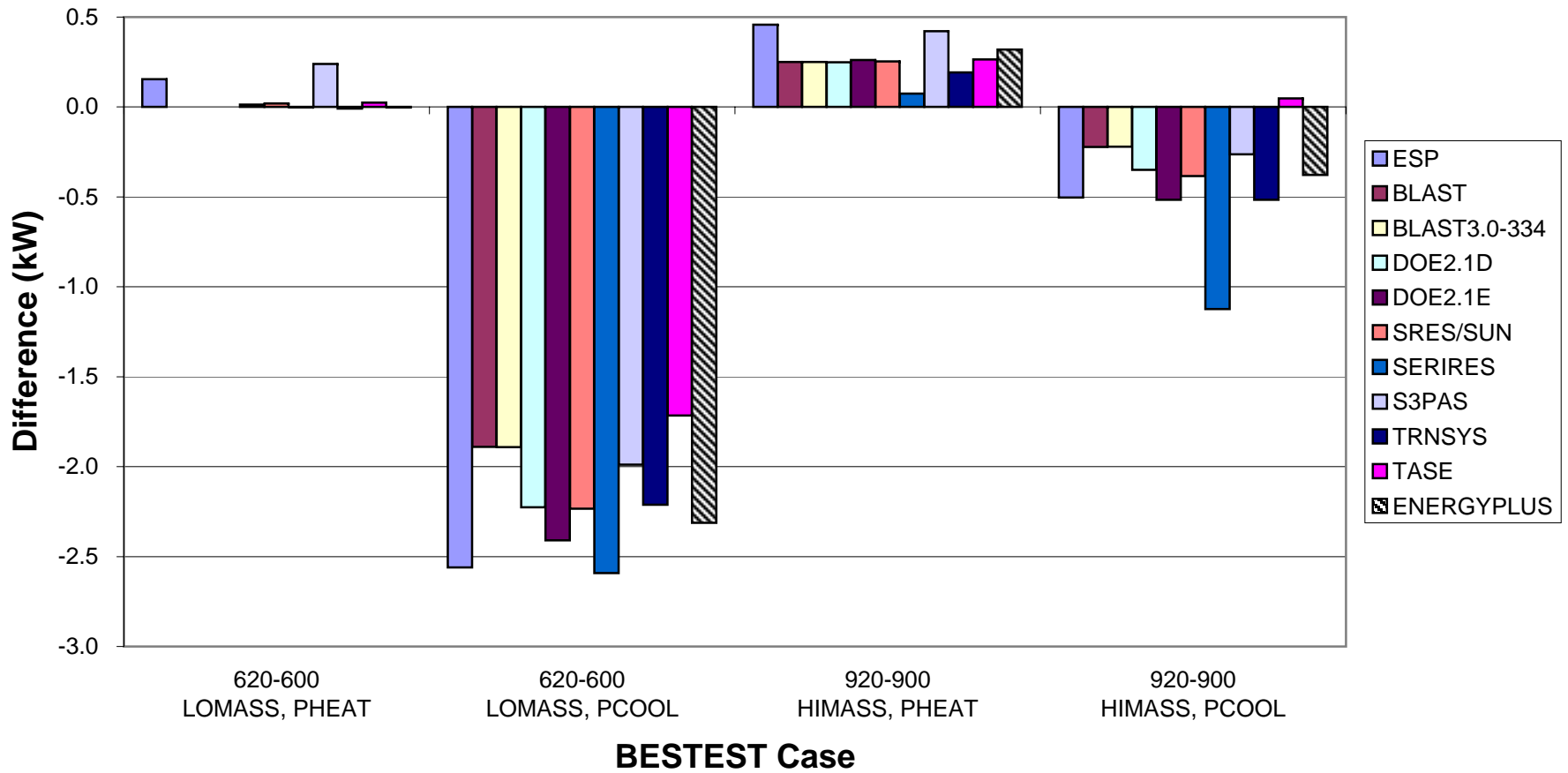

# BESTEST Comparison (Denver, dry/cold) East & West Shaded Window (Delta) Annual Heating and Cooling EnergyPlus Version 1.2.0, Build 029, 5/6/04

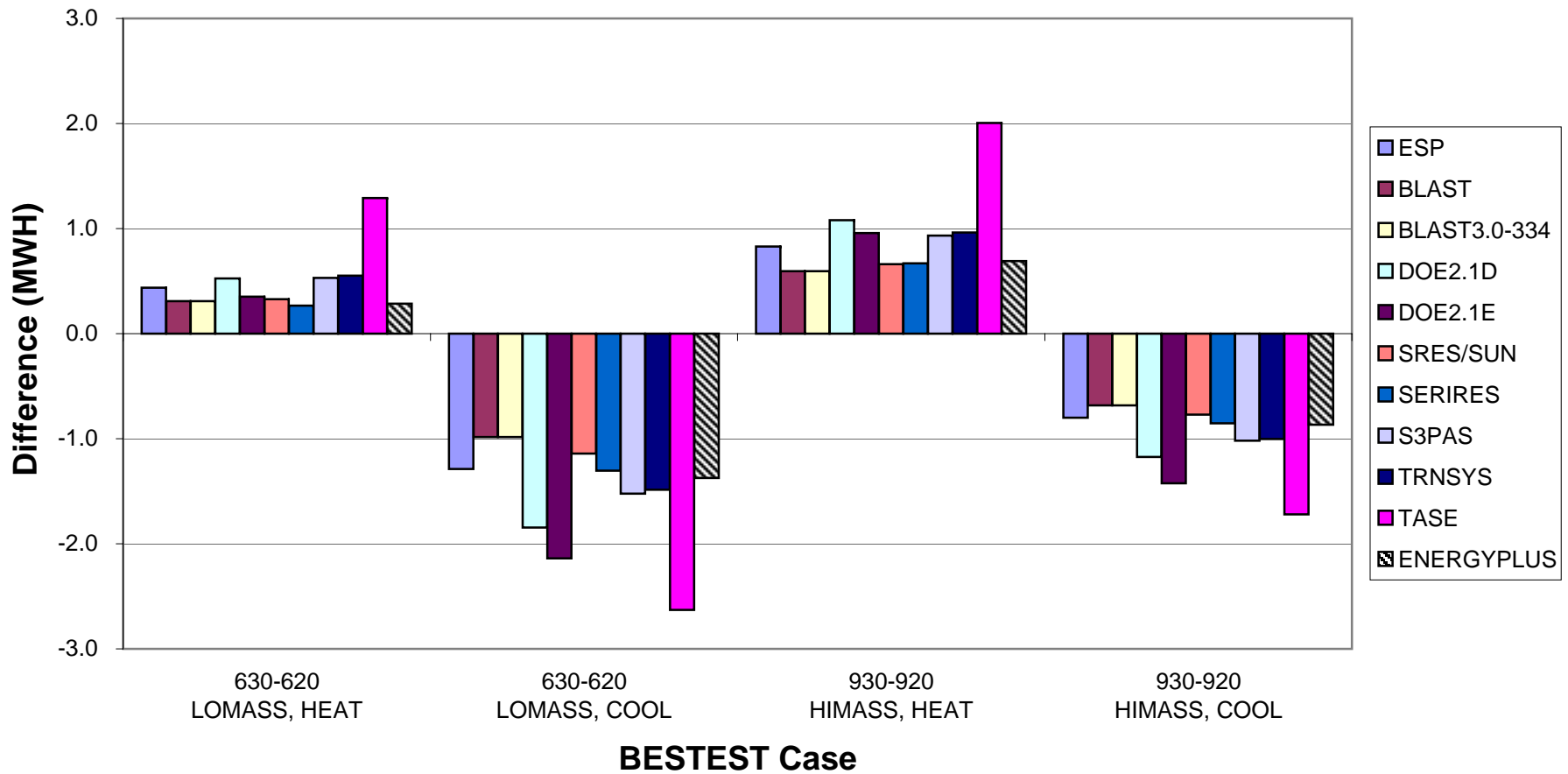

# BESTEST Comparison (Denver, dry/cold) East & West Shaded Window (Delta) Peak Heating and Cooling EnergyPlus Version 1.2.0, Build 029, 5/6/04

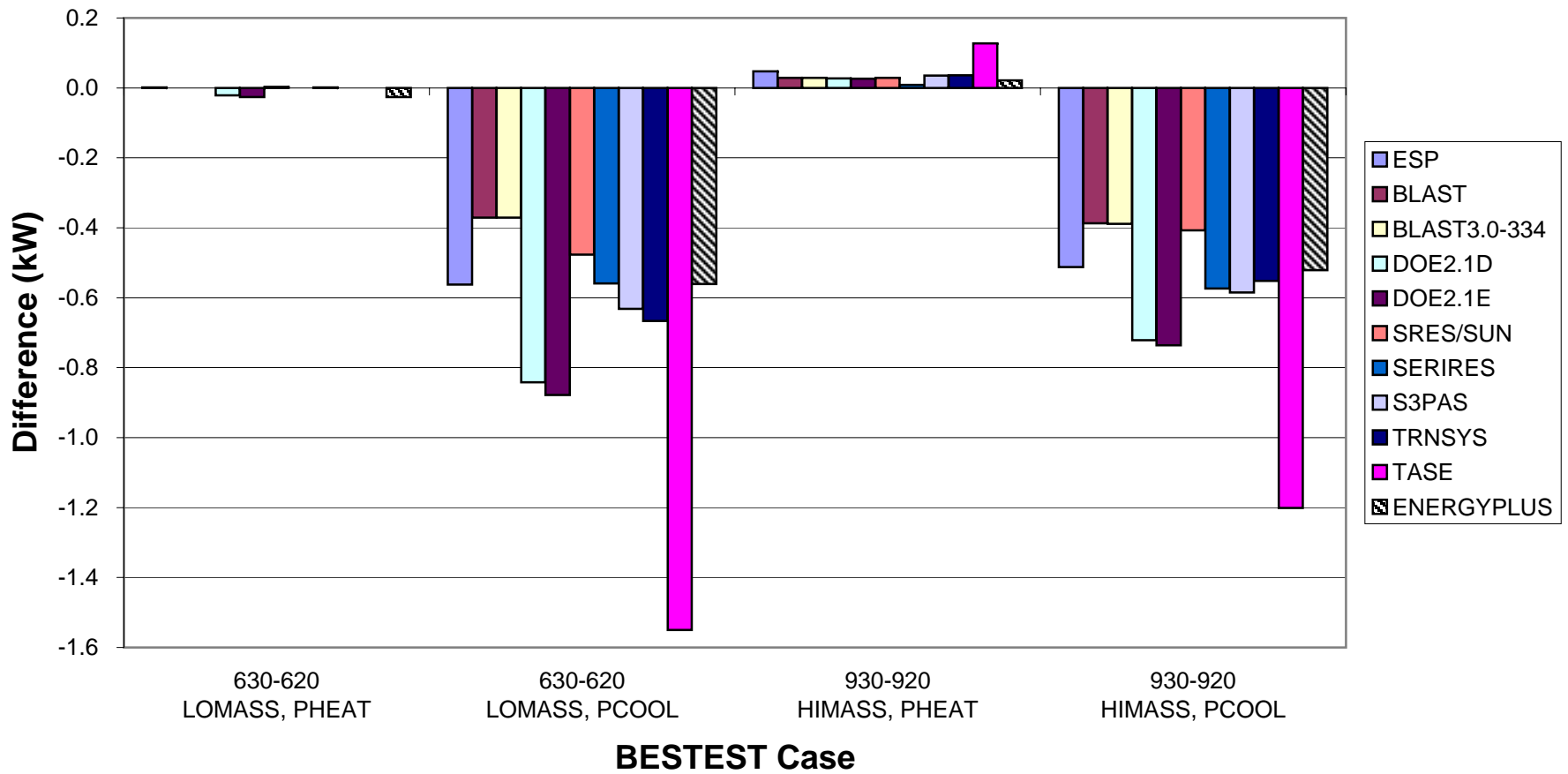

# BESTEST Comparison (Denver, dry/cold) Thermostat Setback (Delta) Annual Heating

EnergyPlus Version 1.2.0, Build 029, 5/6/04

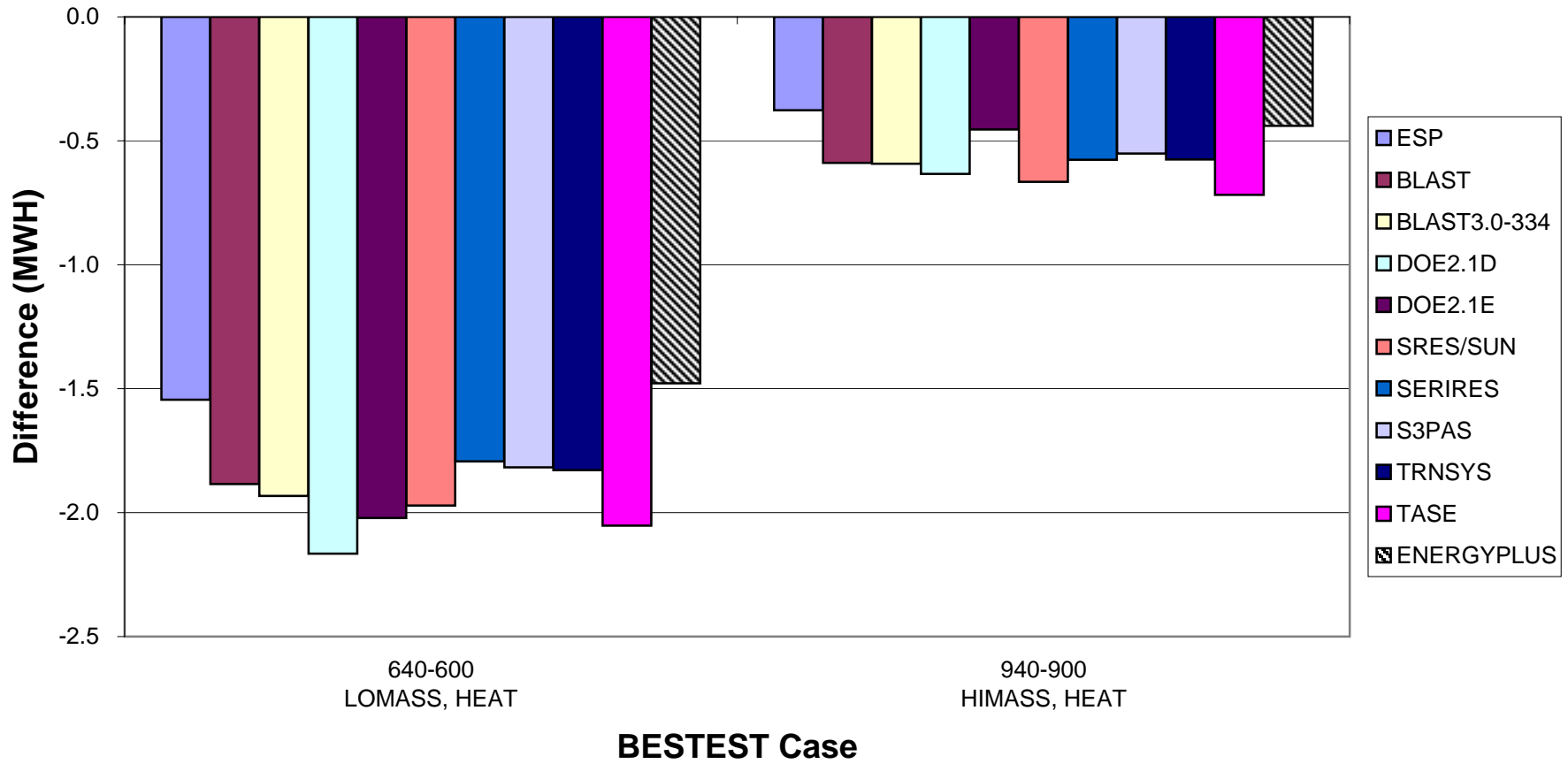

**BESTEST Comparison (Denver, dry/cold)  
Thermostat Setback (Delta)  
Peak Heating  
EnergyPlus Version 1.2.0, Build 029, 5/6/04**

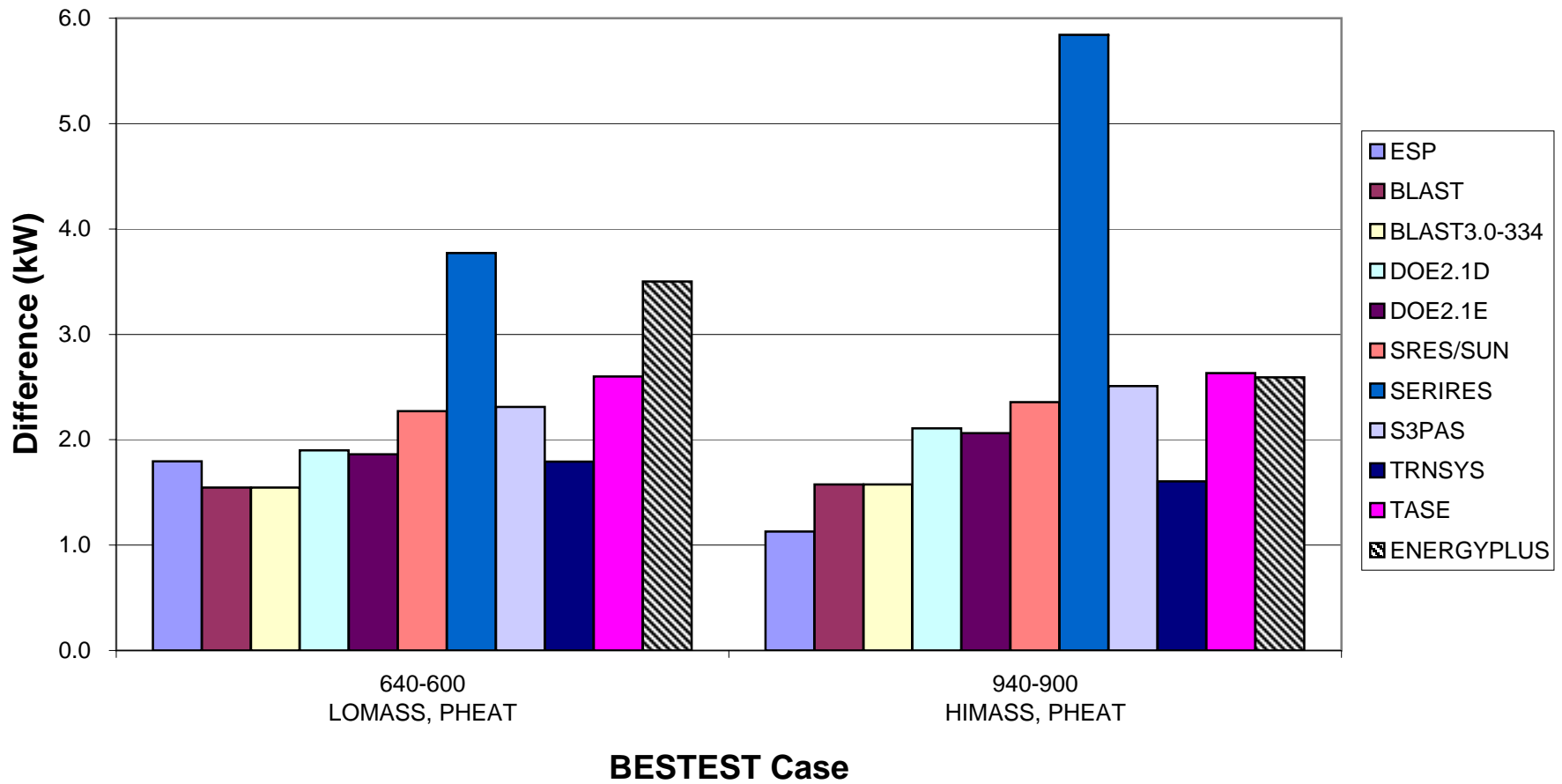



# BESTEST Comparison (Denver, dry/cold) Vent Cooling (Delta) Annual Cooling

EnergyPlus Version 1.2.0, Build 029, 5/6/04

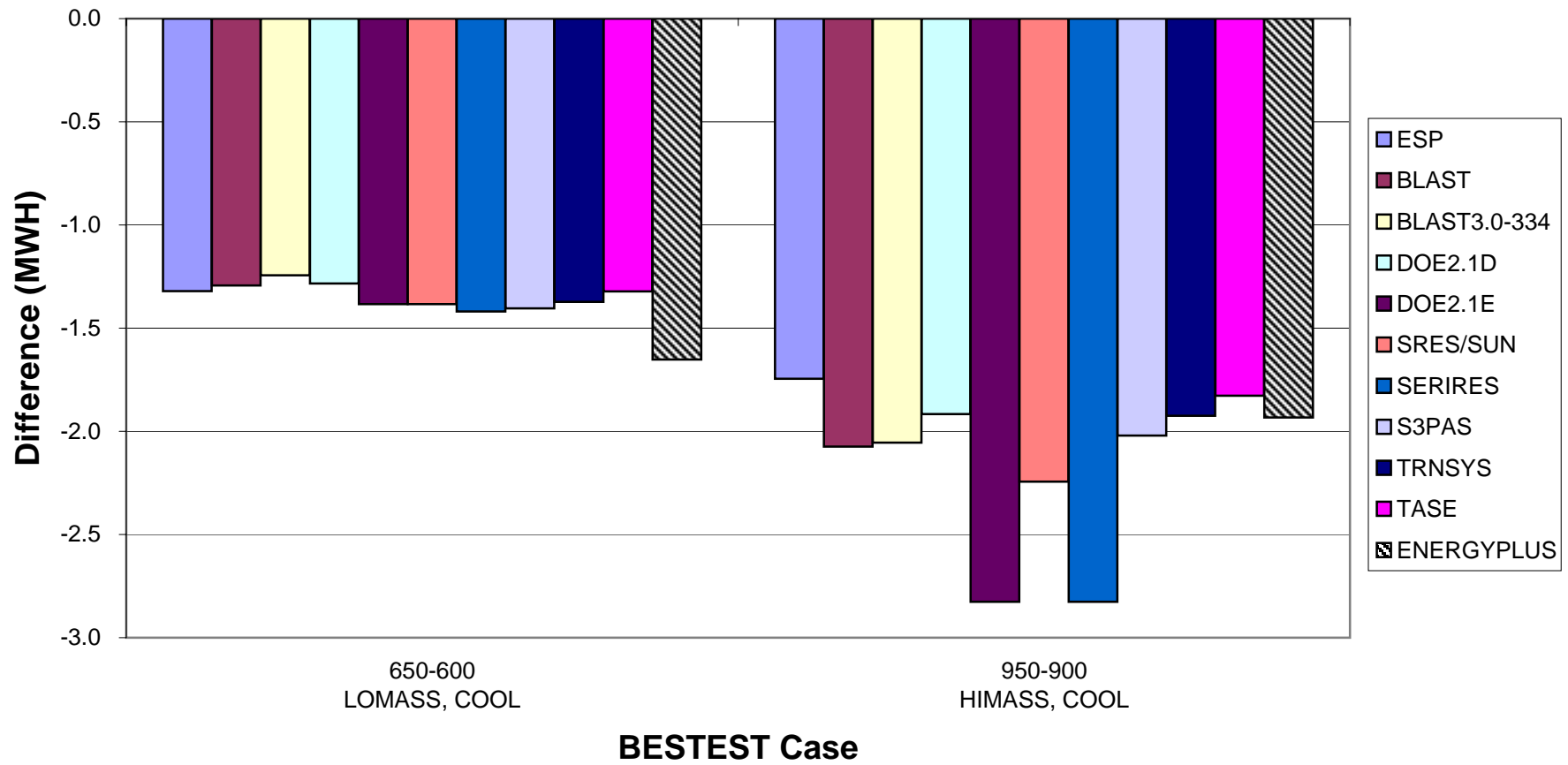

# BESTEST Comparison (Denver, dry/cold) Vent Cooling (Delta) Peak Cooling

EnergyPlus Version 1.2.0, Build 029, 5/6/04

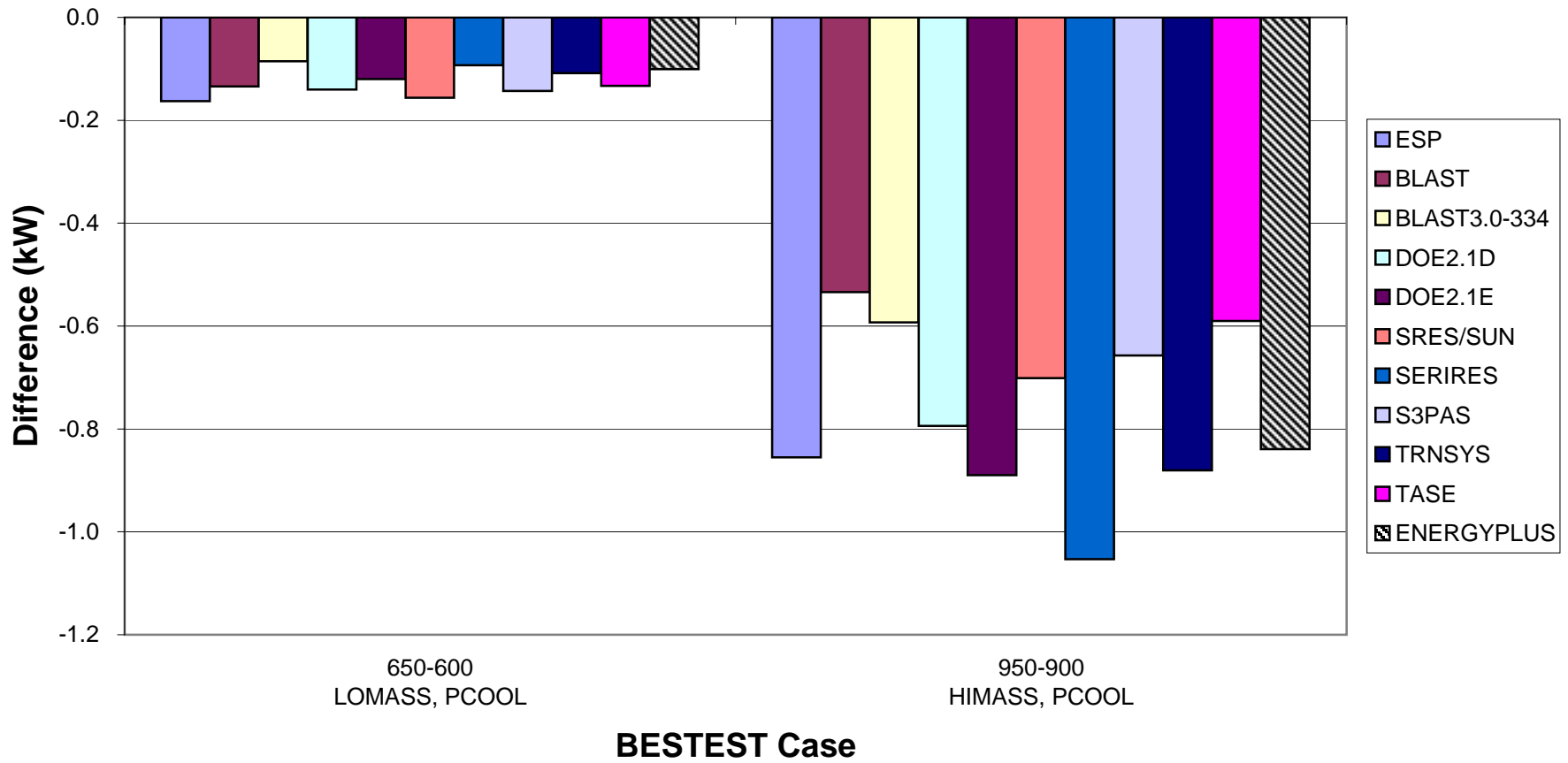

# BESTEST Comparison (Denver, dry/cold) Sunspace (Delta) Annual Heating and Cooling EnergyPlus Version 1.2.0, Build 029, 5/6/04

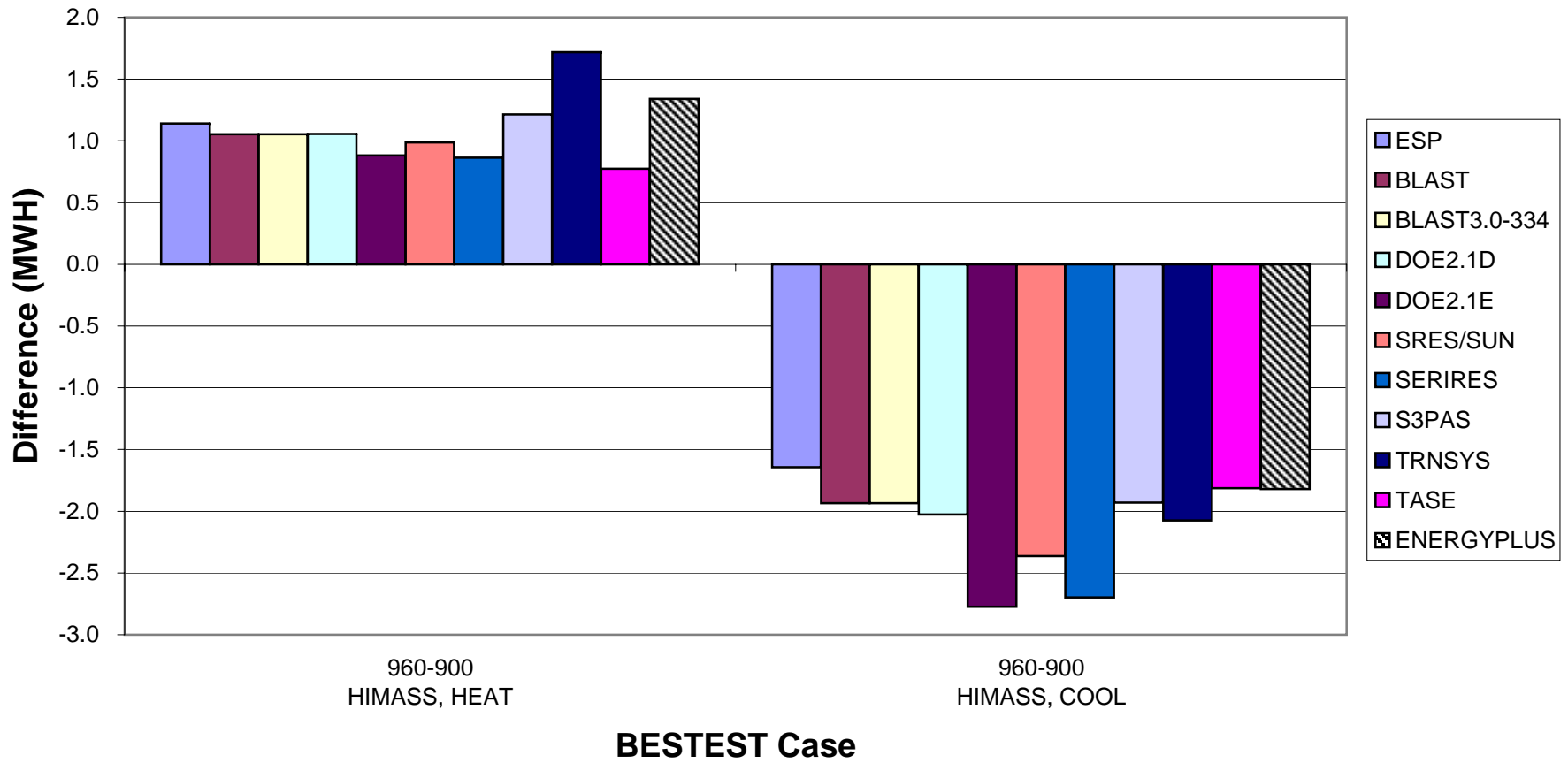

# BESTEST Comparison (Denver, dry/cold)

## Sunspace (Delta)

### Peak Heating and Cooling

EnergyPlus Version 1.2.0, Build 029, 5/6/04

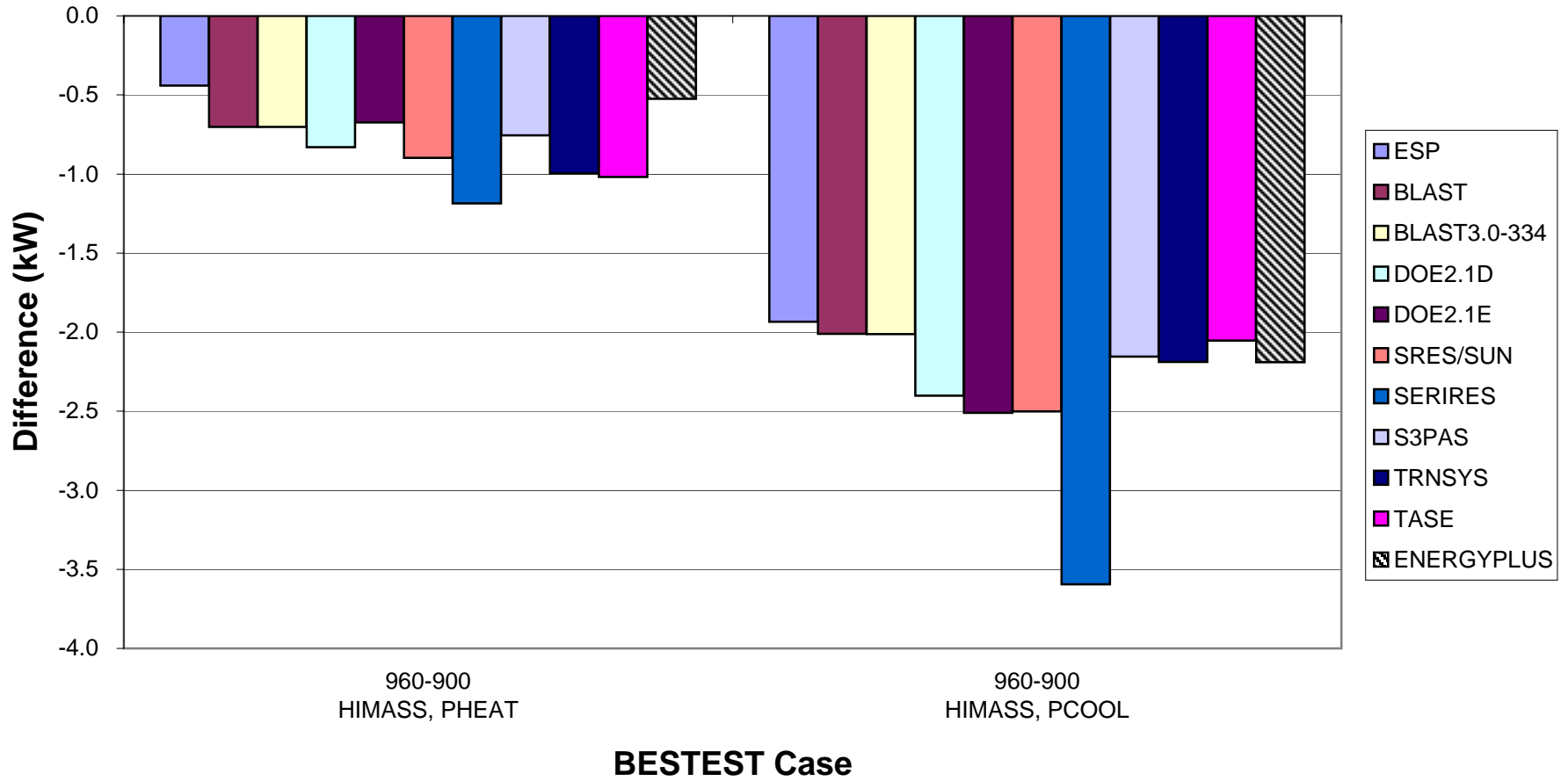

## **Appendix D**

### **Historical Changes in BESTEST Results for Various Releases of EnergyPlus**



## BESTEST Comparison (Denver, dry/cold) for Release Versions of EnergyPlus Low Mass Building Annual Heating

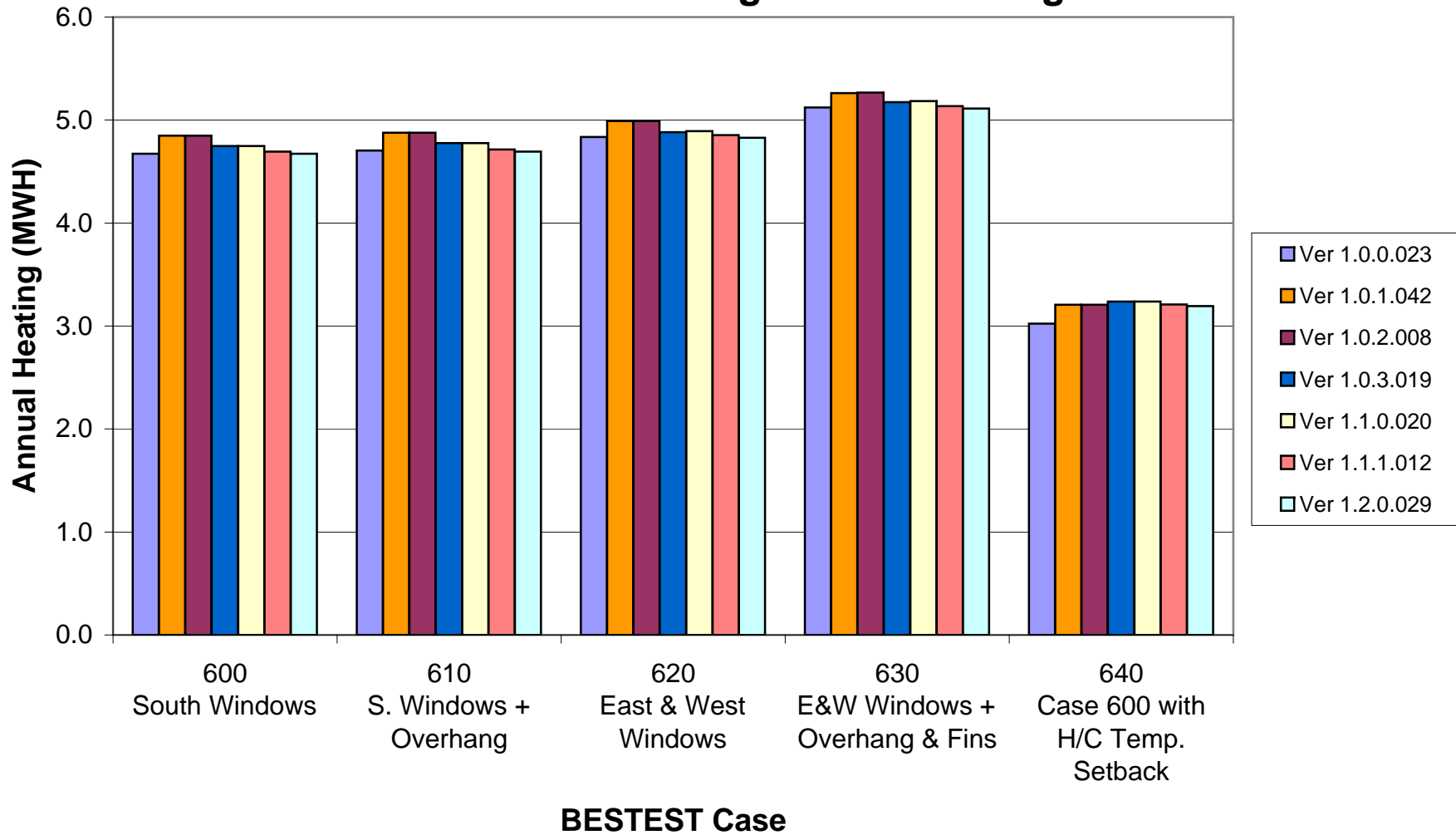

## BESTEST Comparison (Denver, dry/cold) for Release Versions of EnergyPlus Low Mass Building Annual Cooling

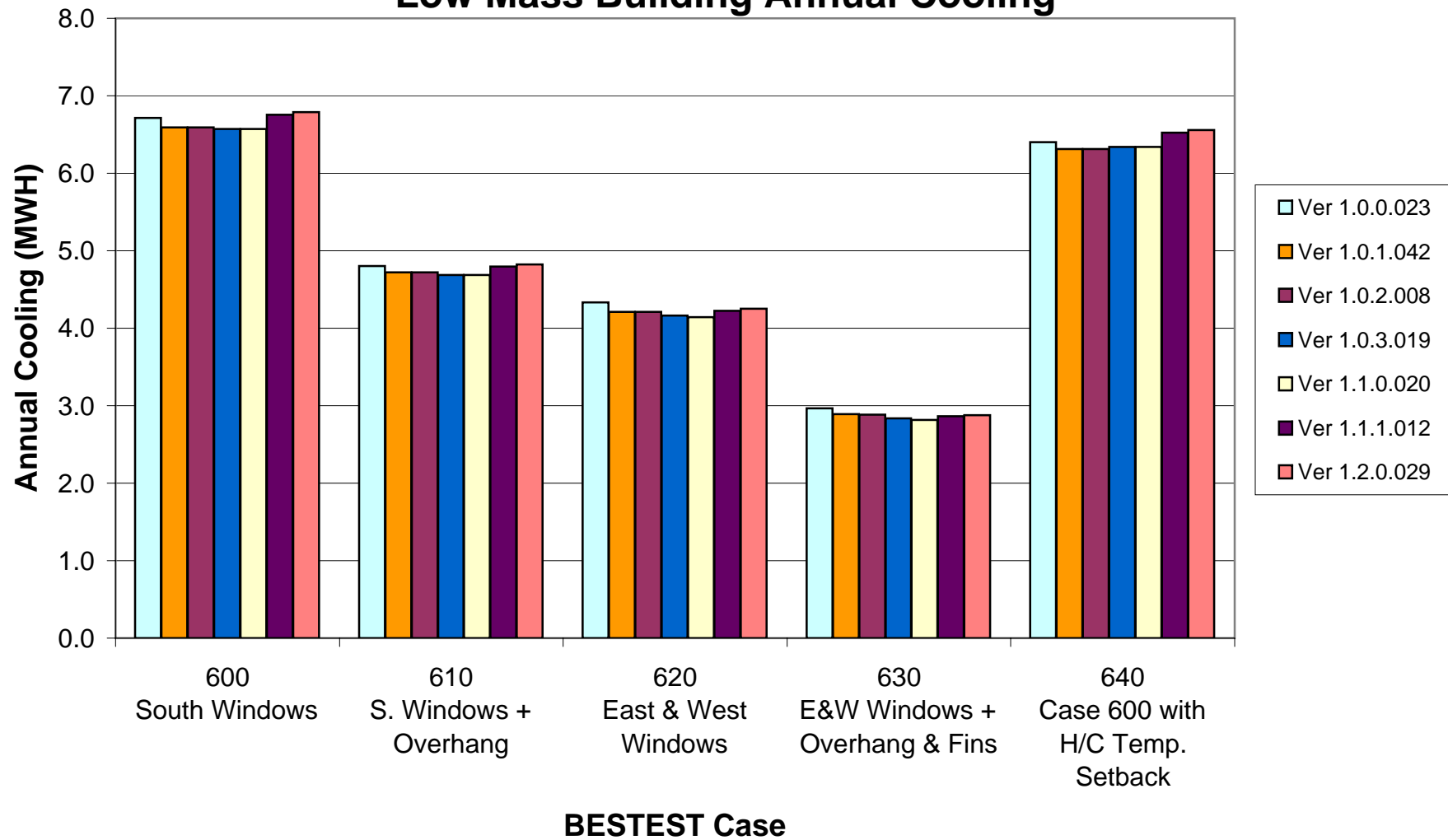



## BESTEST Comparison (Denver, dry/cold) for Release Versions of EnergyPlus Low Mass Building Peak Heating

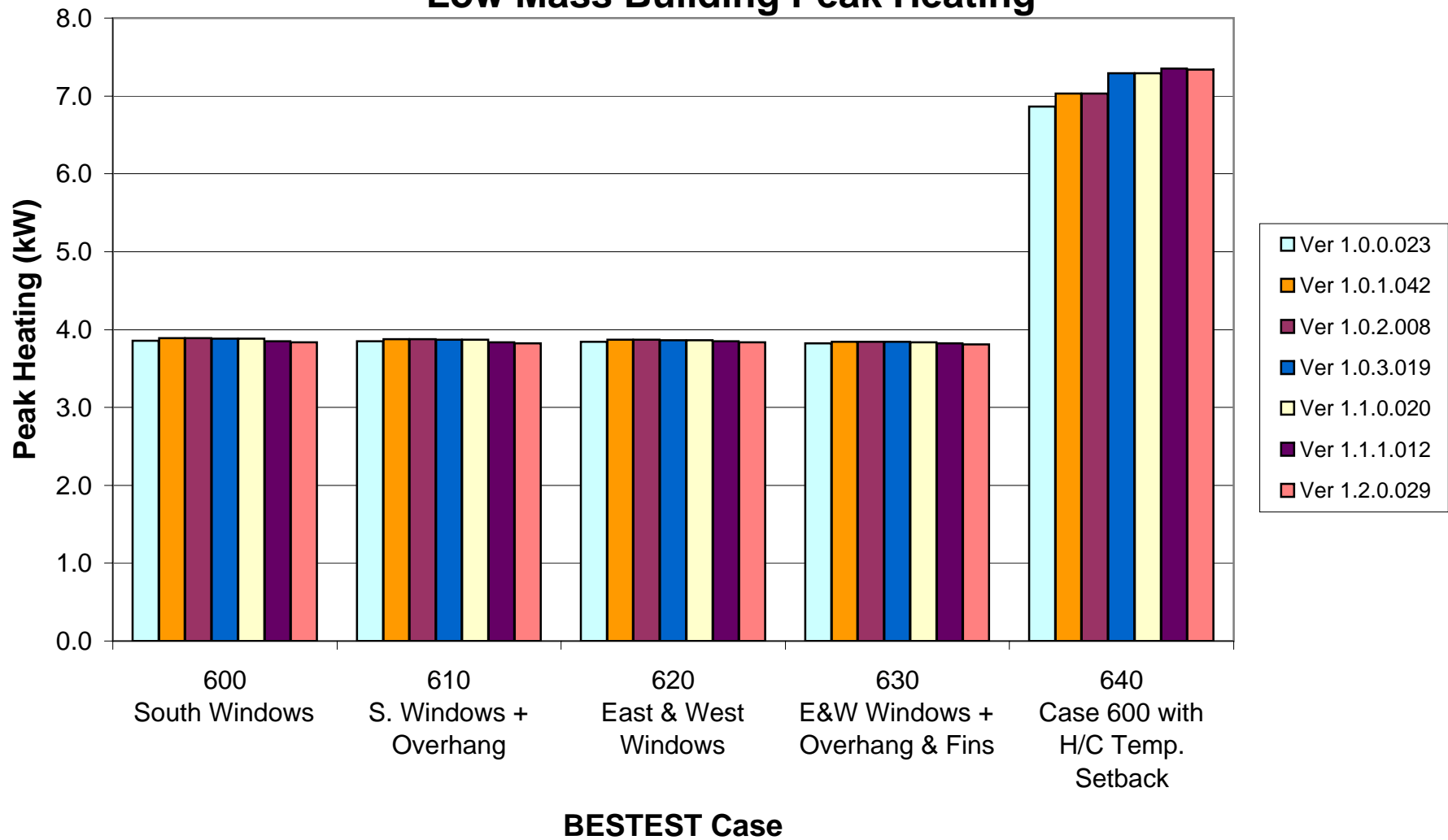

## BESTEST Comparison (Denver, dry/cold) for Release Versions of EnergyPlus Low Mass Building Peak Cooling

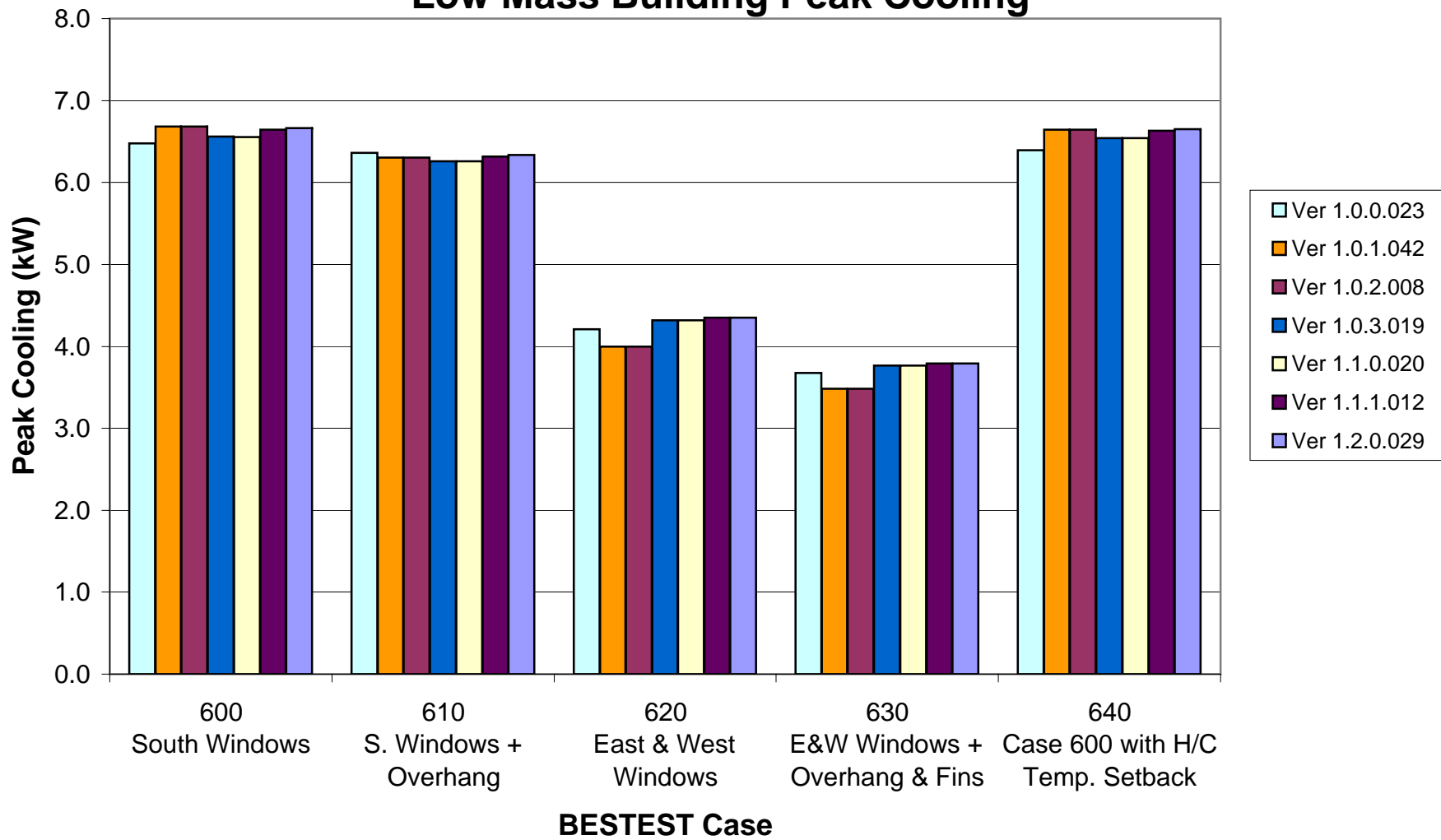

## BESTEST Comparison (Denver, dry/cold) for Release Versions of EnergyPlus High Mass Building Annual Heating

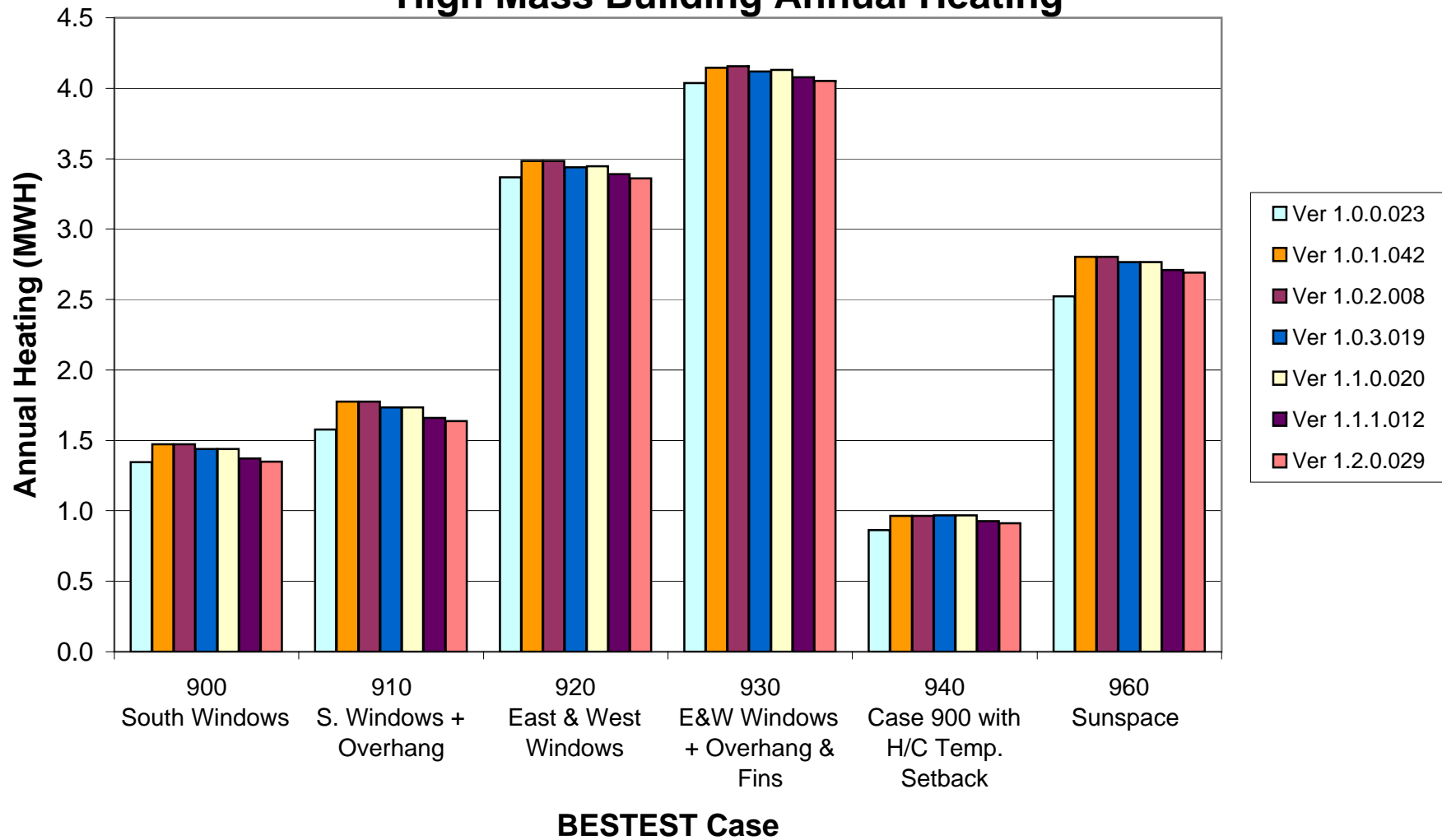

## BESTEST Comparison (Denver, dry/cold) for Release Versions of EnergyPlus High Mass Building Annual Cooling

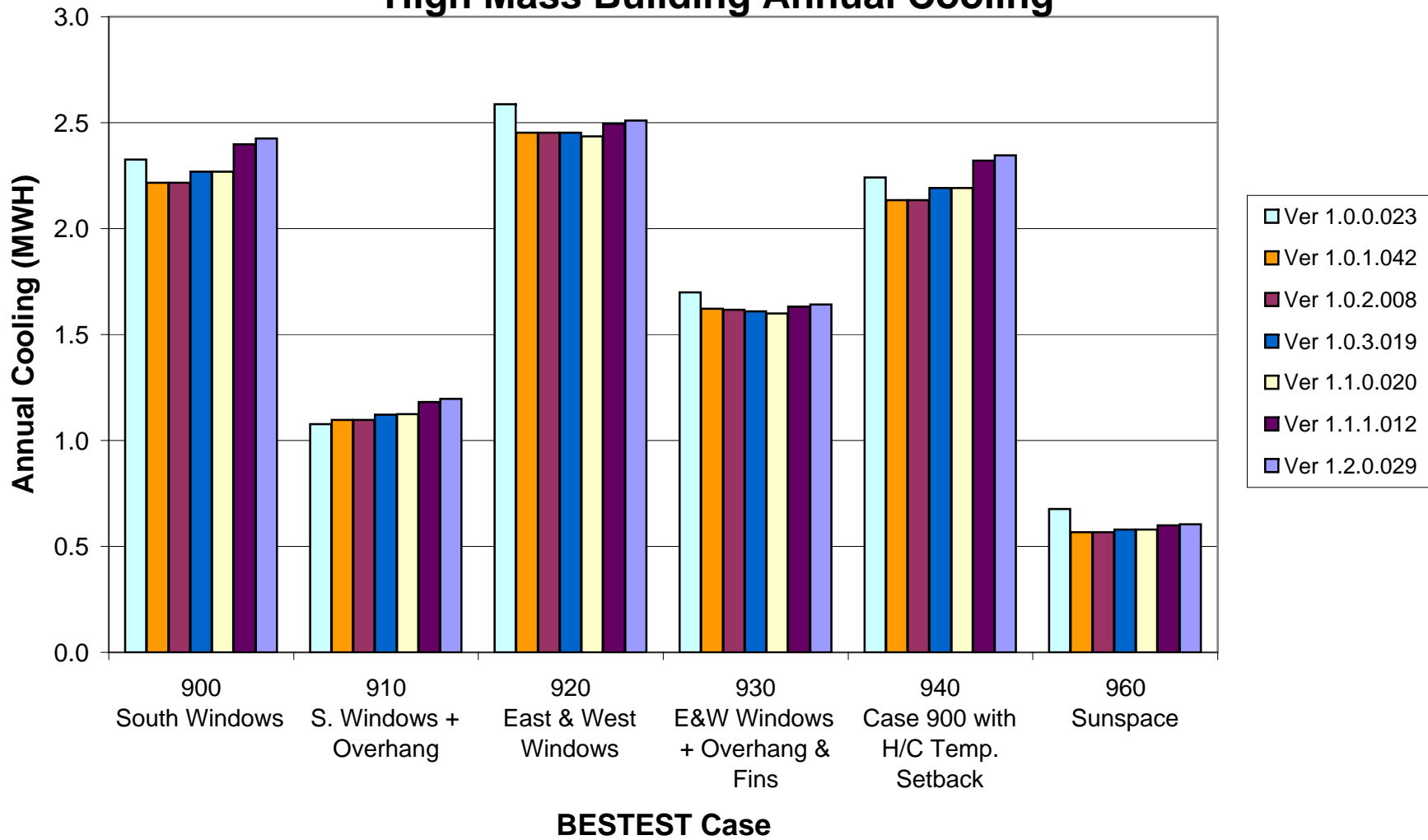

## BESTEST Comparison (Denver, dry/cold) for Release Versions of EnergyPlus High Mass Building Peak Heating

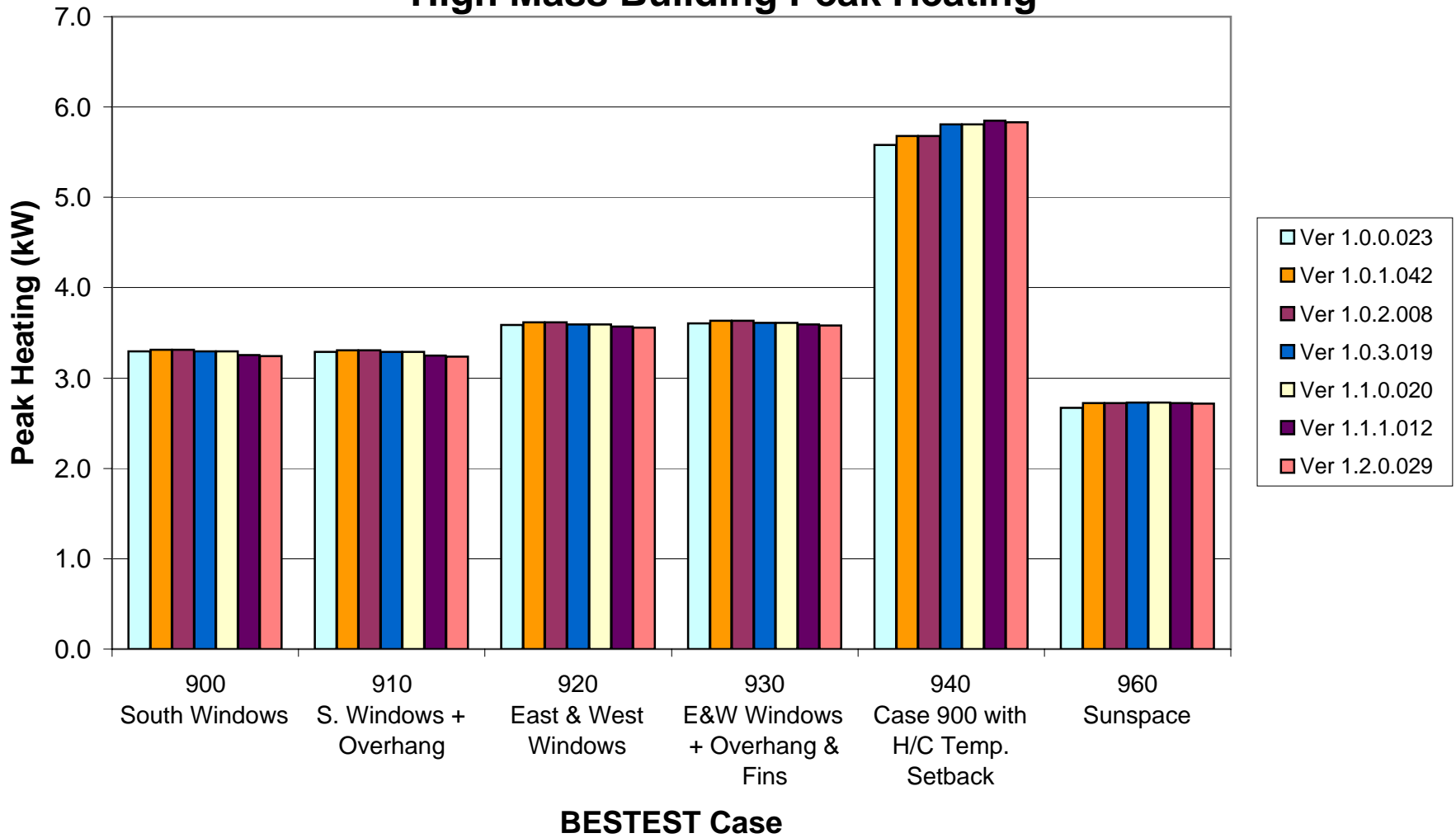

## BESTEST Comparison (Denver, dry/cold) for Release Versions of EnergyPlus High Mass Building Peak Cooling

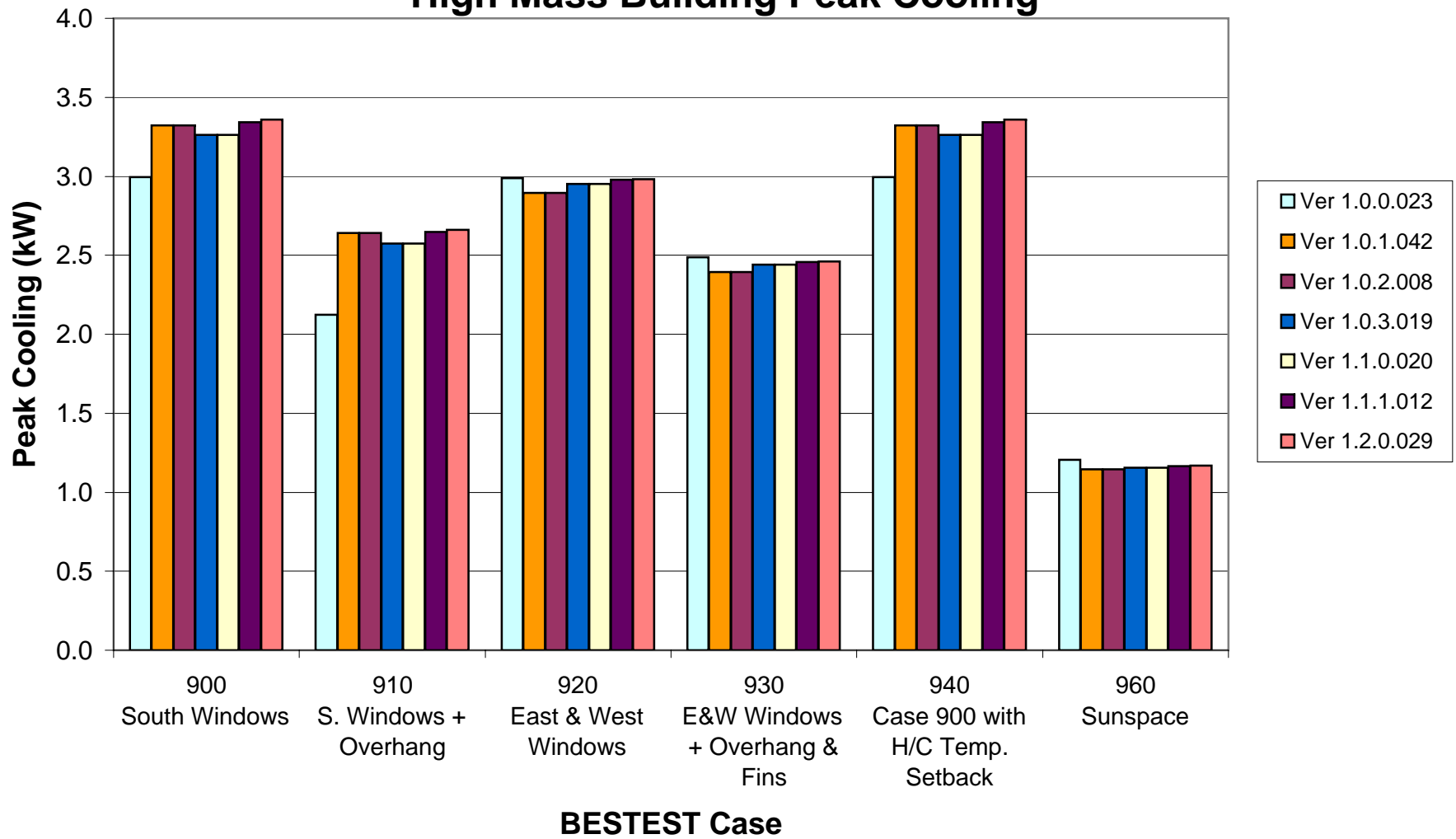

# BESTEST Comparison (Denver, dry/cold) for Release Versions of EnergyPlus Free Floating Maximum Temperature

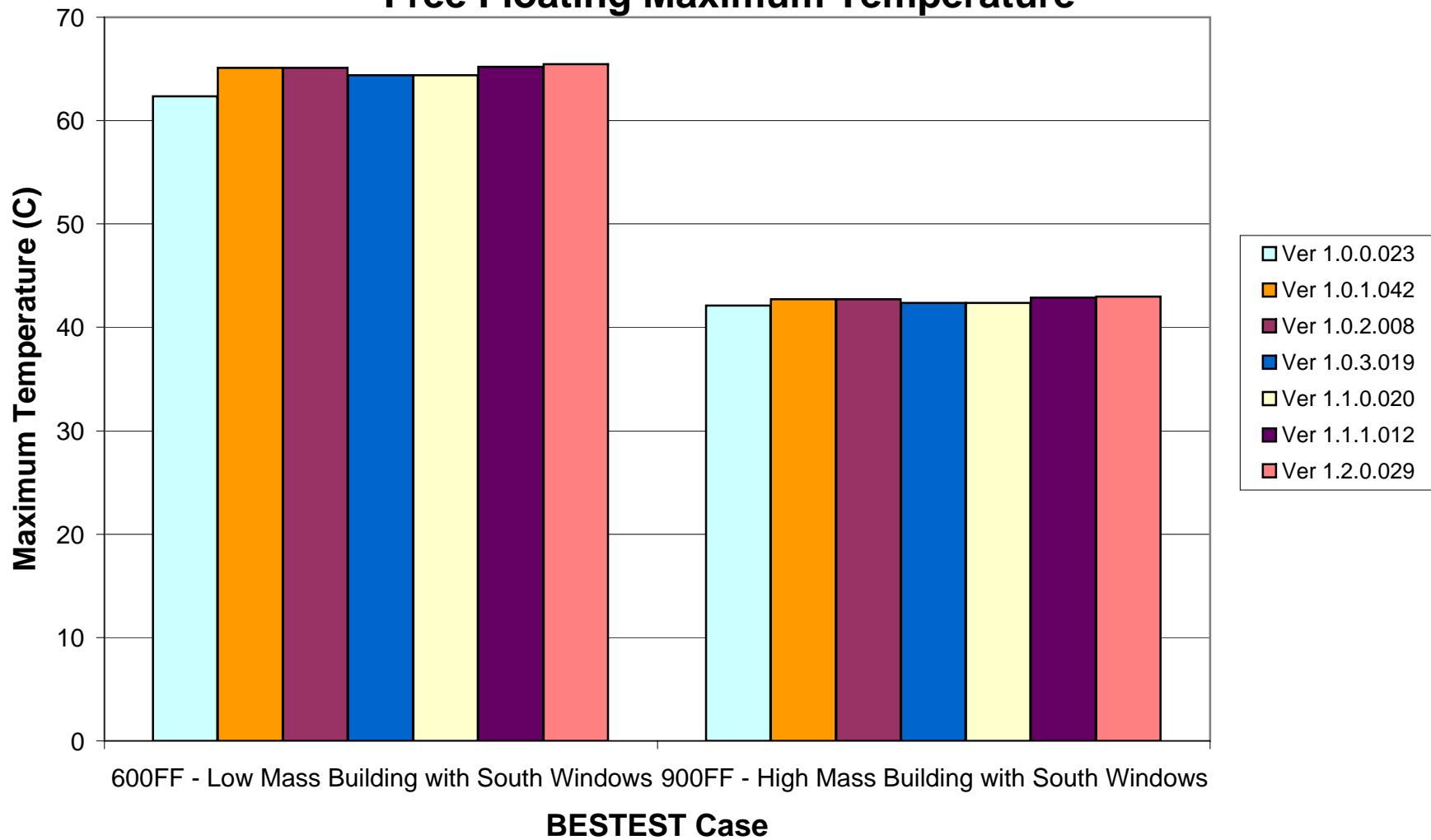

# BESTEST Comparison (Denver, dry/cold) for Release Versions of EnergyPlus Free Floating Minimum Temperature

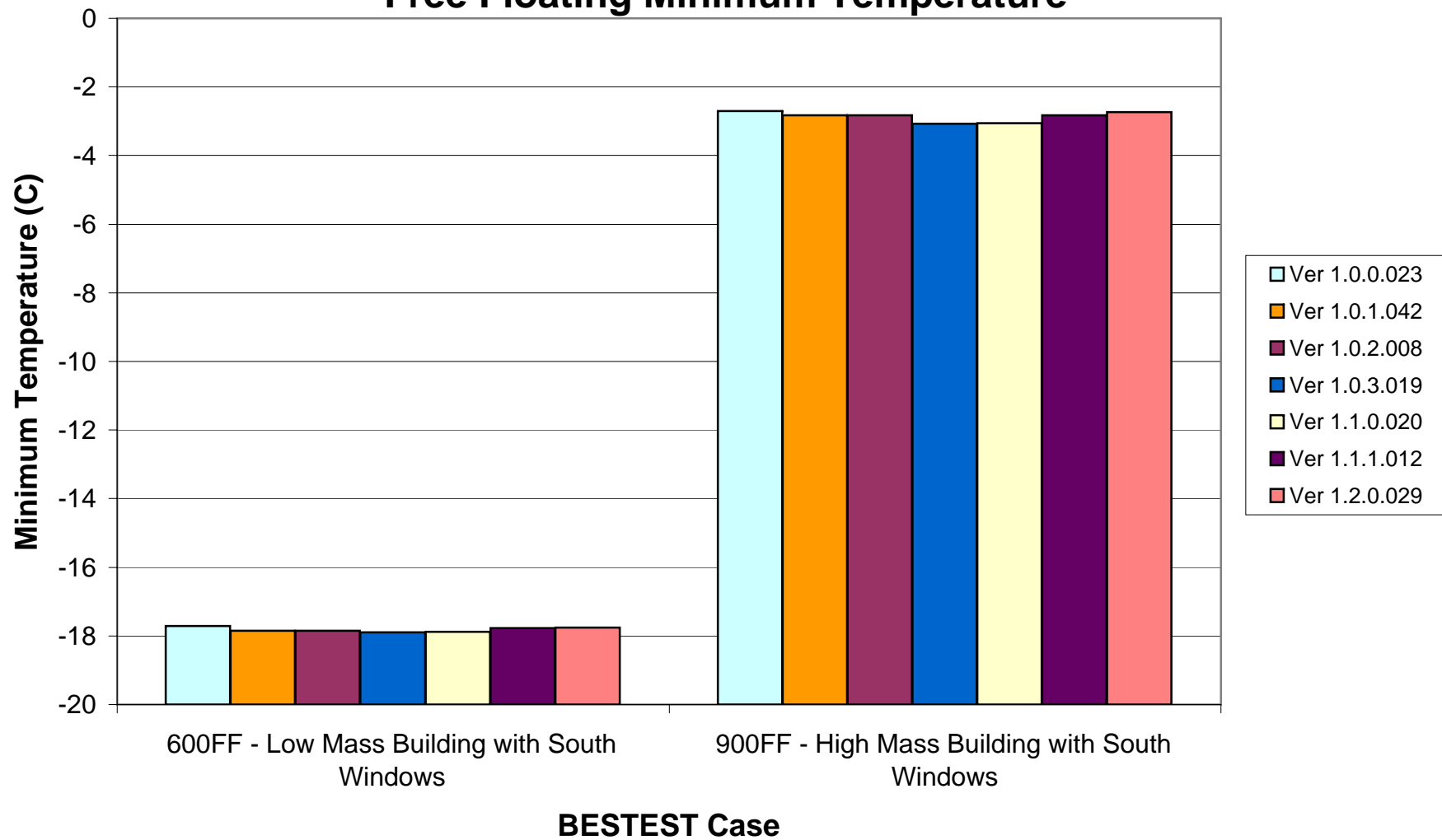



# BESTEST Comparison (Denver, dry/cold) for Release Versions of EnergyPlus Low Mass Building (low absorptances, no windows)

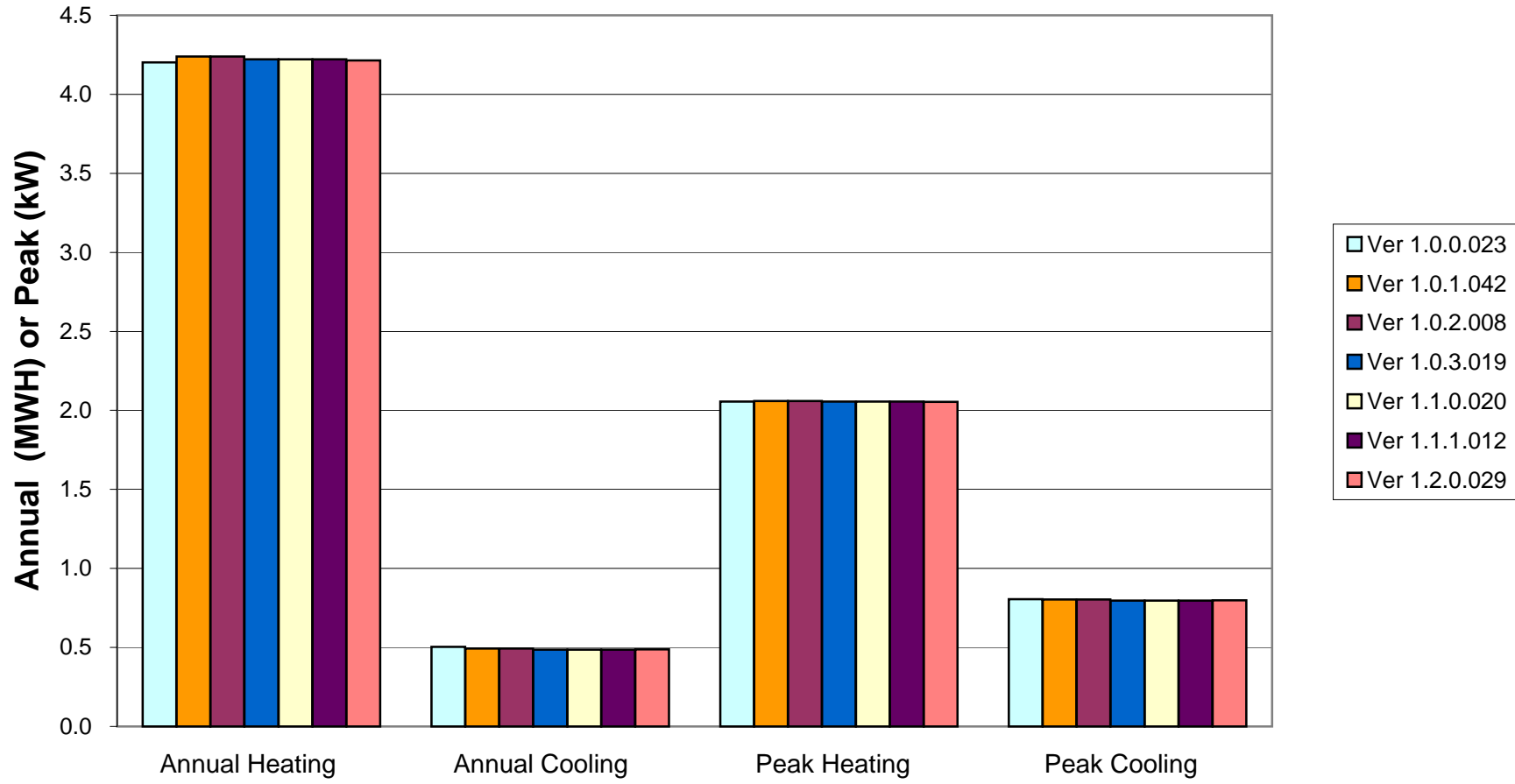

**BESTEST Case 195**

# BESTEST Comparison (Denver, dry/cold) for Release Versions of EnergyPlus South Shaded Window (Delta) Annual Heating and Cooling

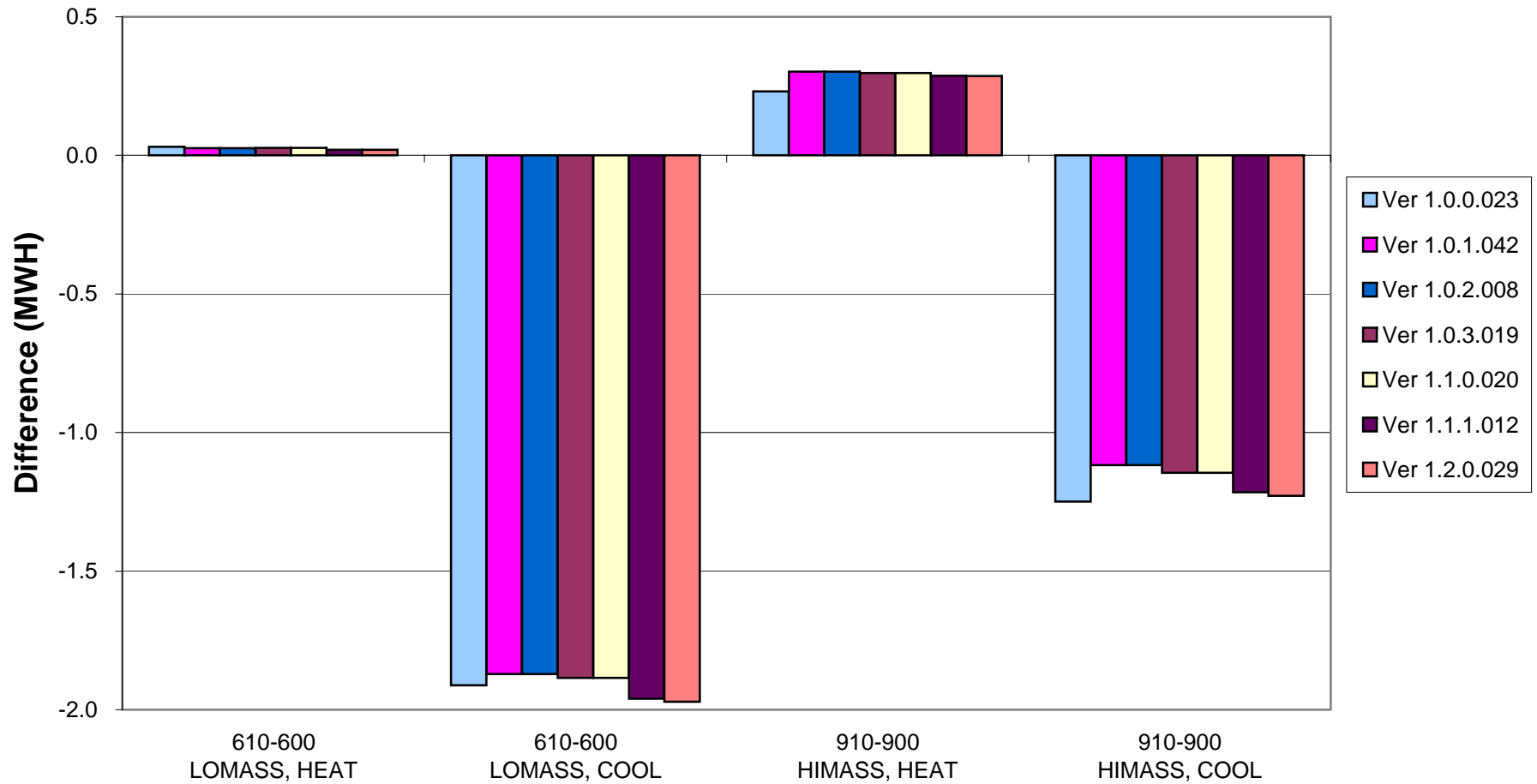

# BESTEST Comparison (Denver, dry/cold) for Release Versions of EnergyPlus South Shaded Window (Delta) Peak Heating and Cooling

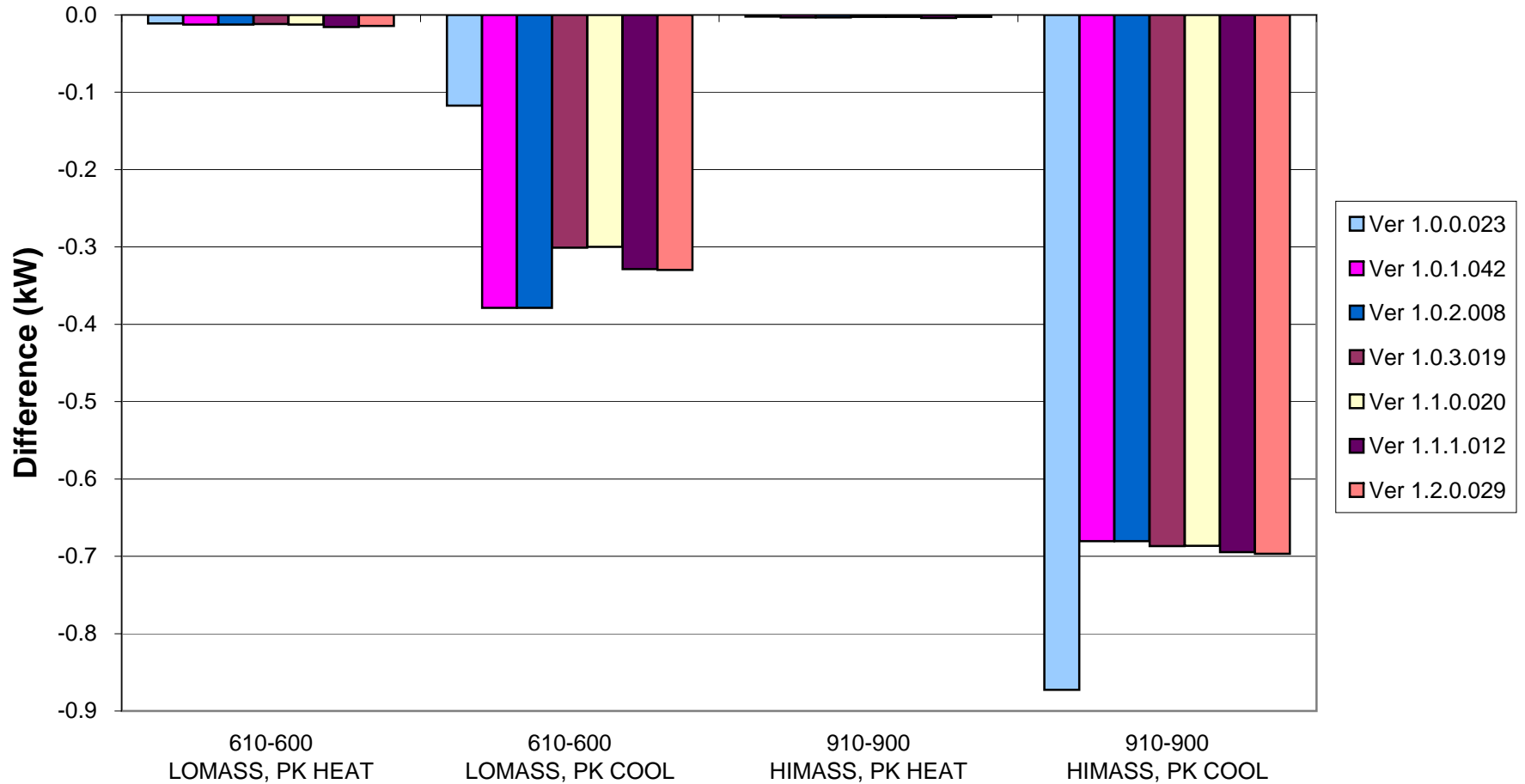

# BESTEST Comparison (Denver, dry/cold) for Release Versions of EnergyPlus East & West Window (Delta) Annual Heating and Cooling

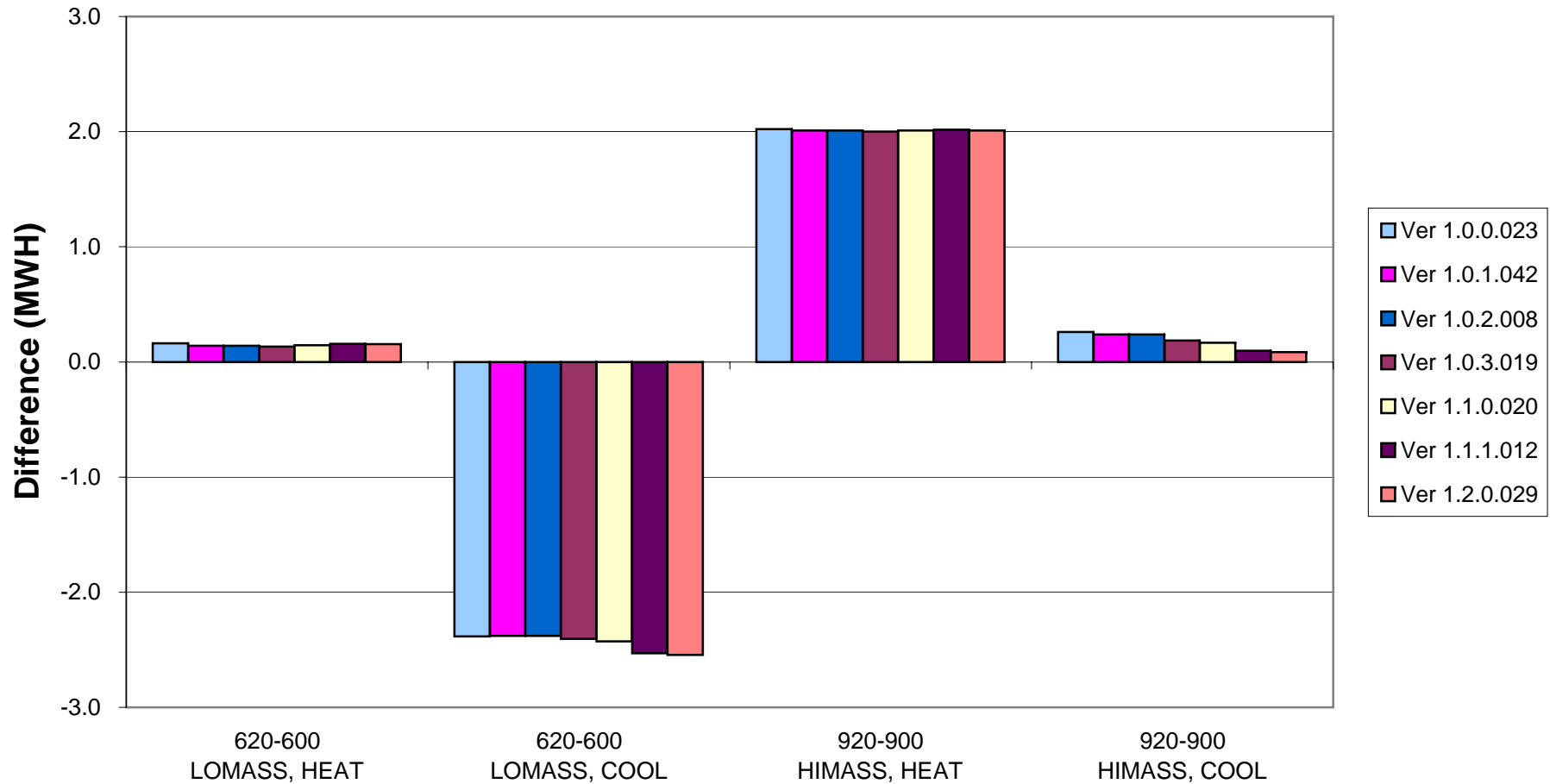

# BESTEST Comparison (Denver, dry/cold) for Release Versions of EnergyPlus East & West Window (Delta) Peak Heating and Cooling

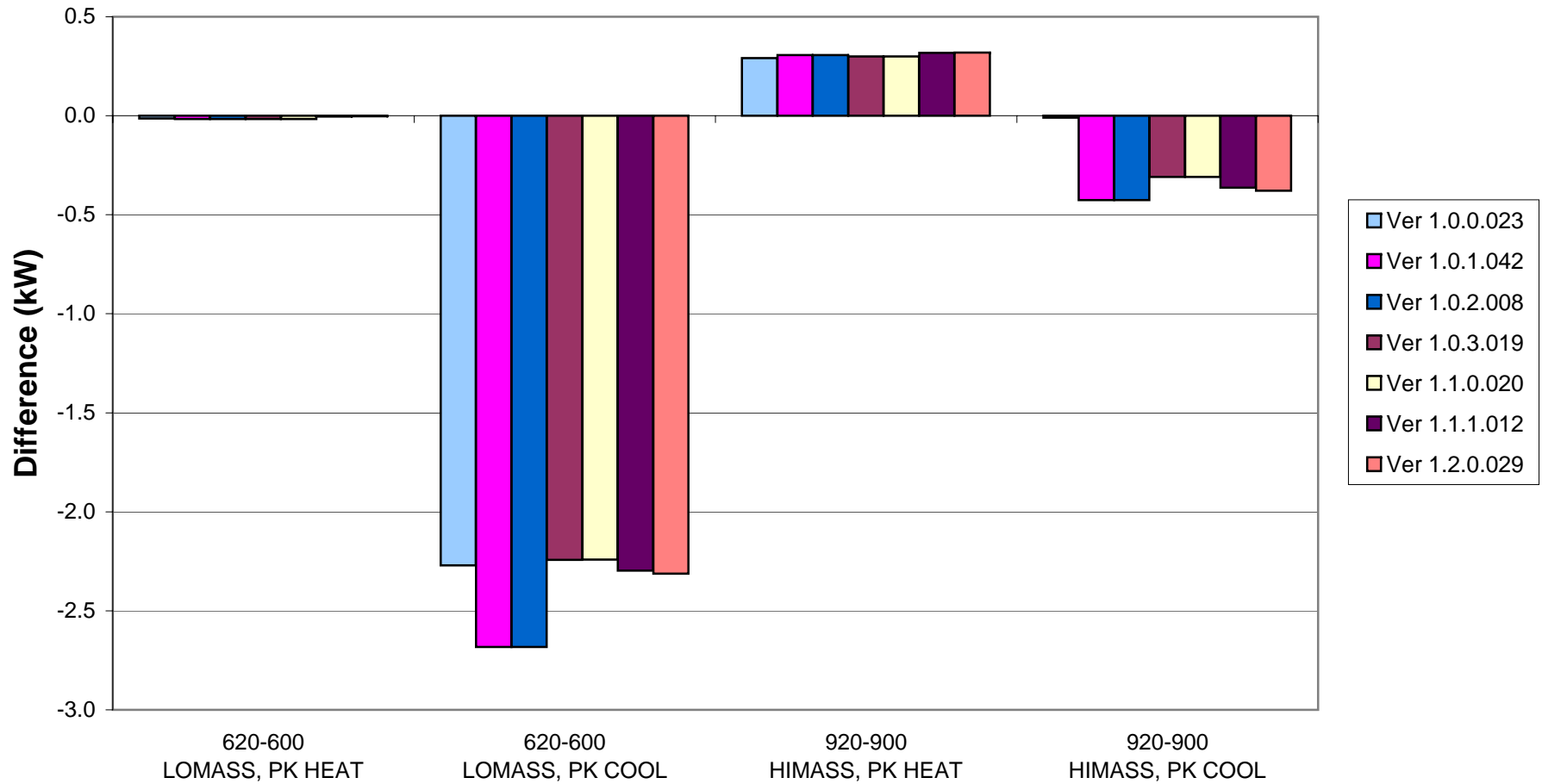

# BESTEST Comparison (Denver, dry/cold) for Release Versions of EnergyPlus East & West Shaded Window (Delta) Annual Heating and Cooling

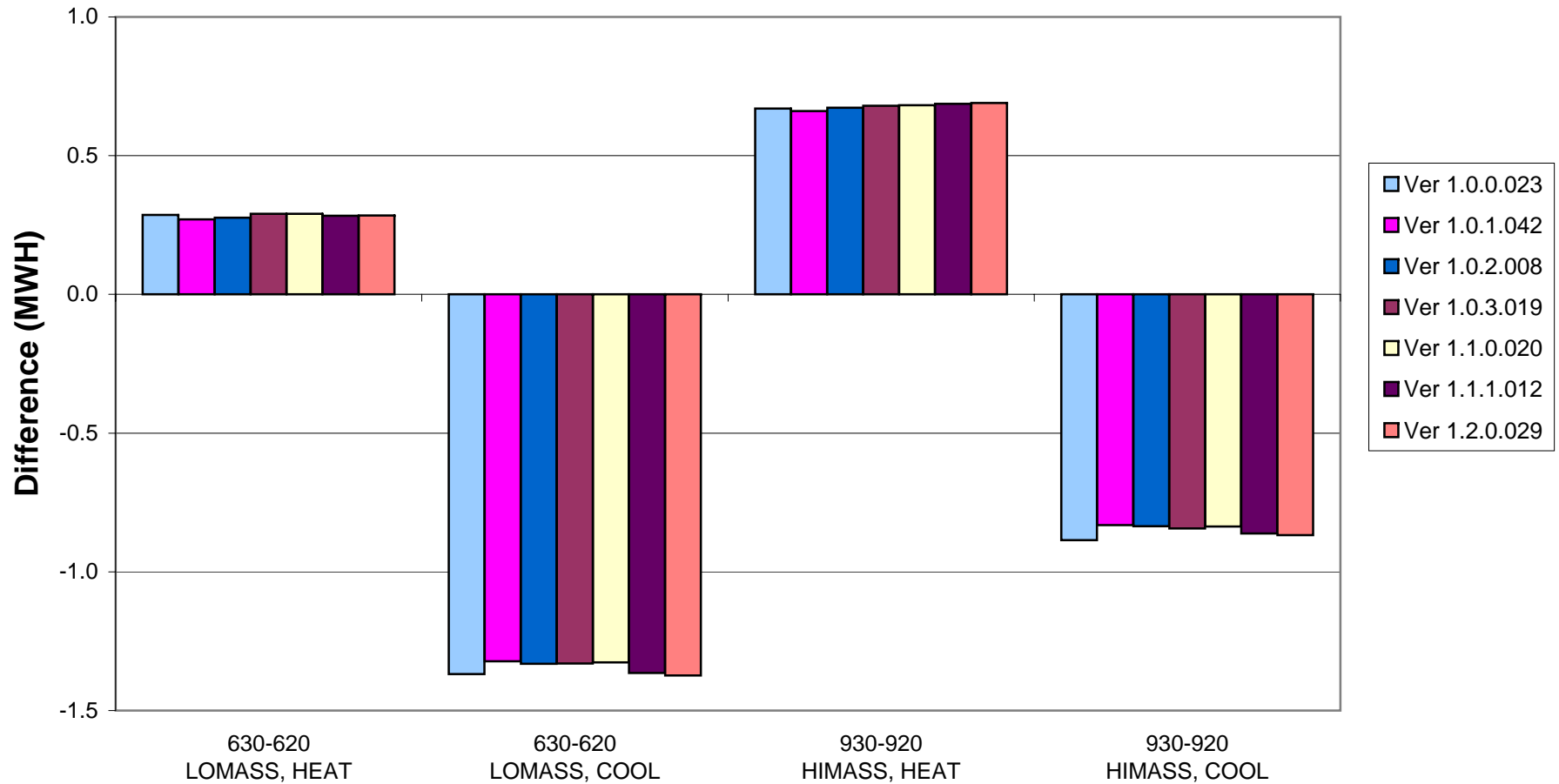

# BESTEST Comparison (Denver, dry/cold) for Release Versions of EnergyPlus East & West Shaded Window (Delta) Peak Heating and Cooling

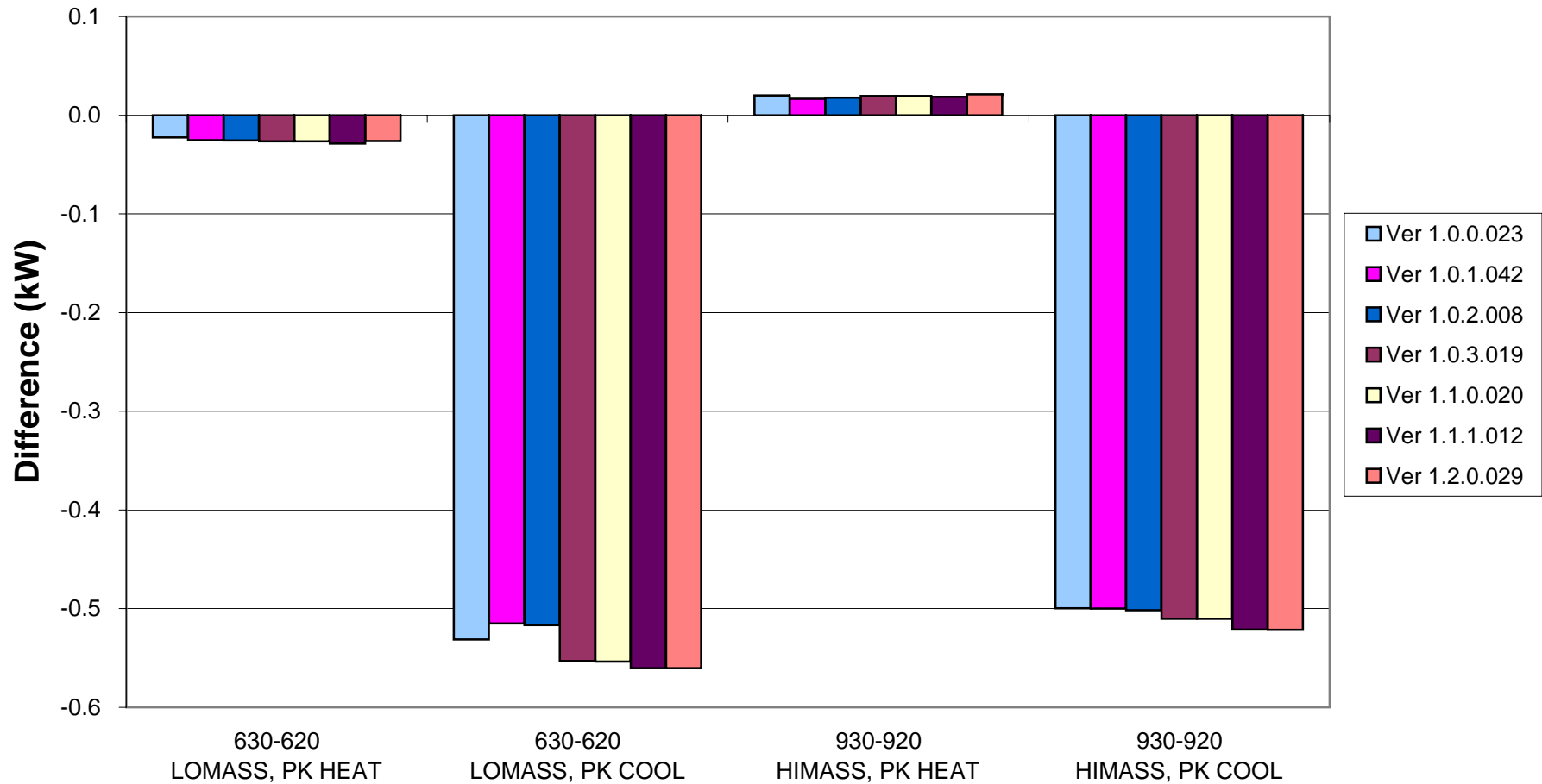

# BESTEST Comparison (Denver, dry/cold) for Release Versions of EnergyPlus Thermostat Setback (Delta) Annual Heating and Cooling

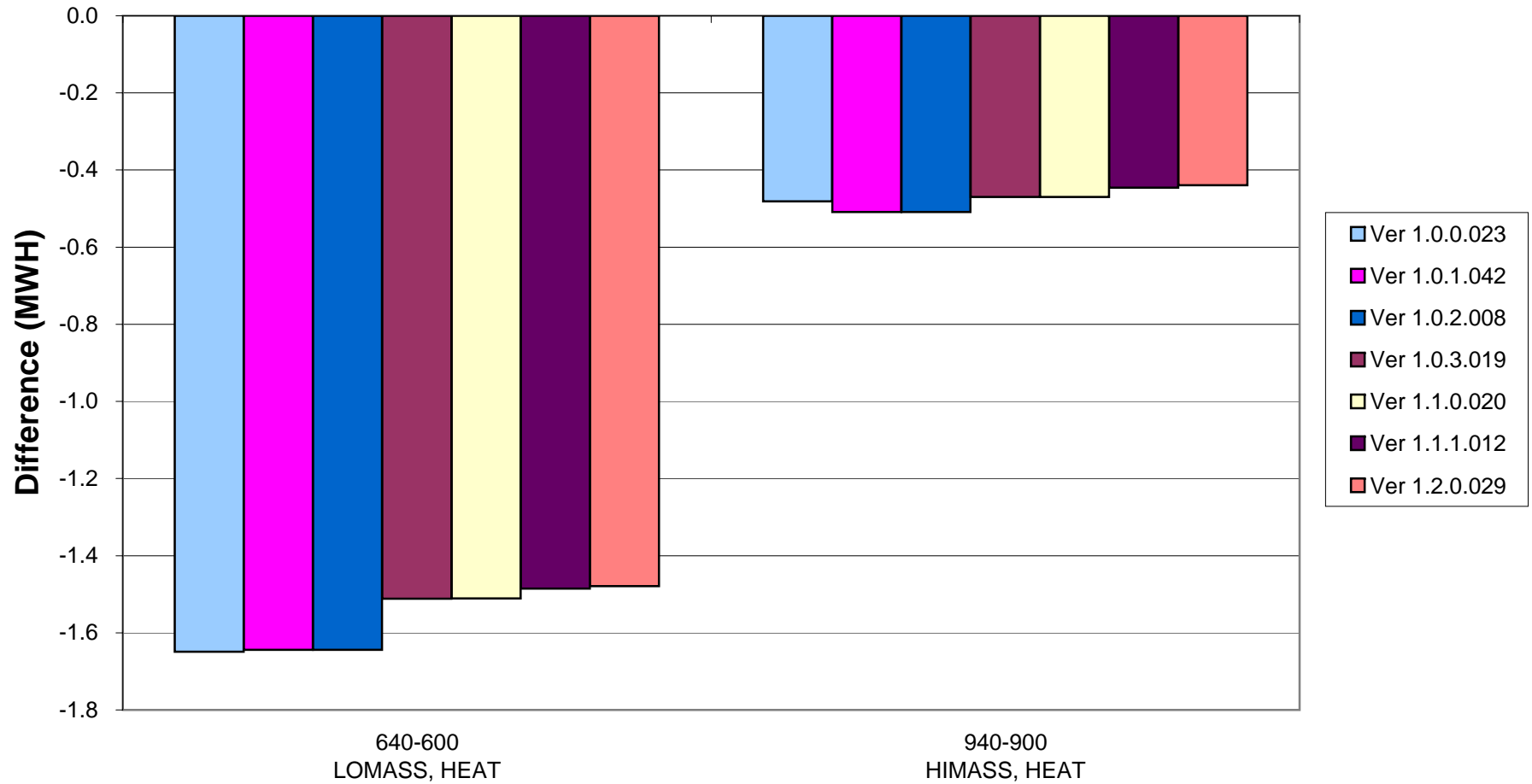



# BESTEST Comparison (Denver, dry/cold) for Release Versions of EnergyPlus Thermostat Setback (Delta) Peak Heating

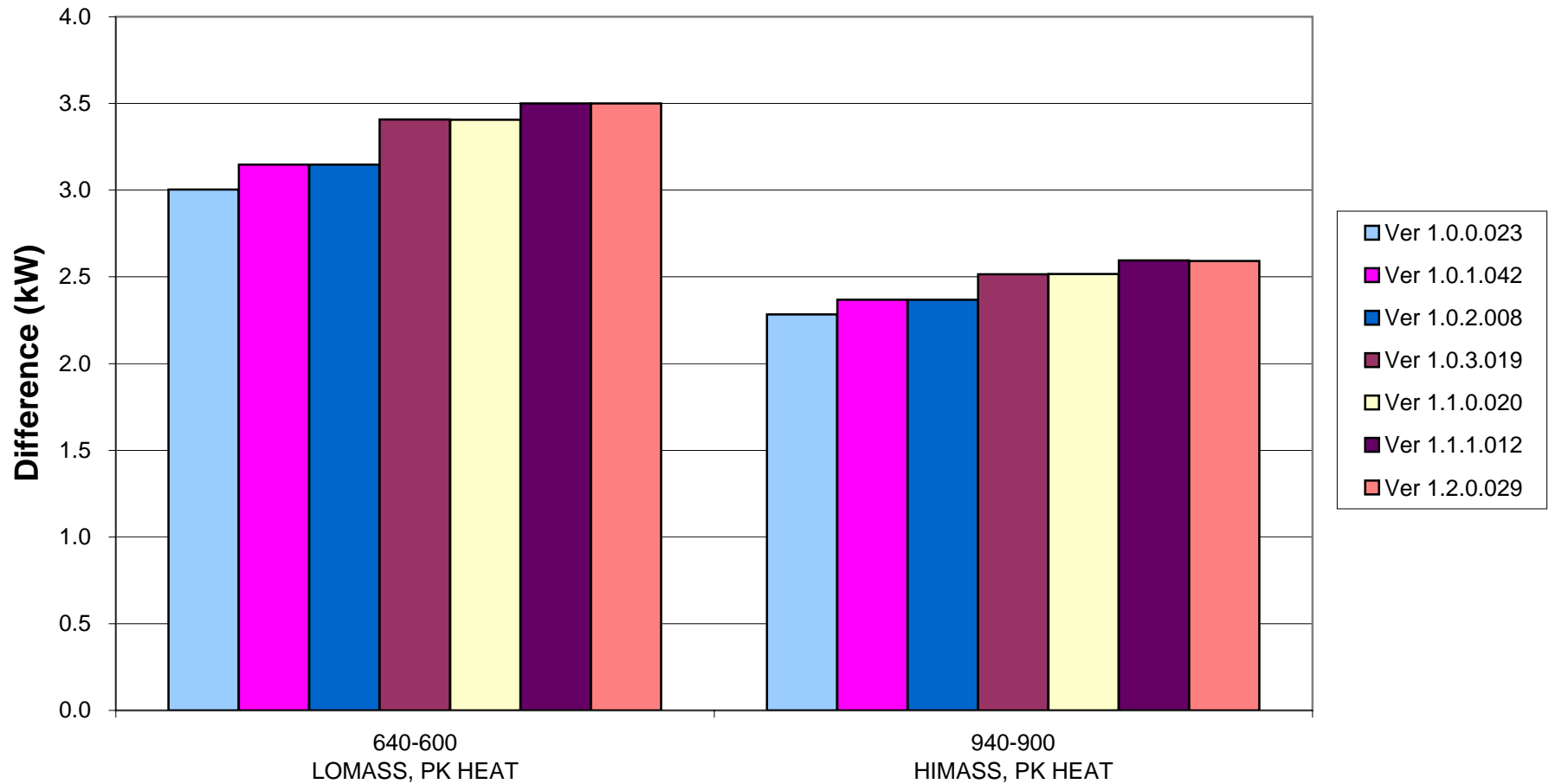

# BESTEST Comparison (Denver, dry/cold) for Release Versions of EnergyPlus Sunspace (Delta) Annual Heating and Cooling

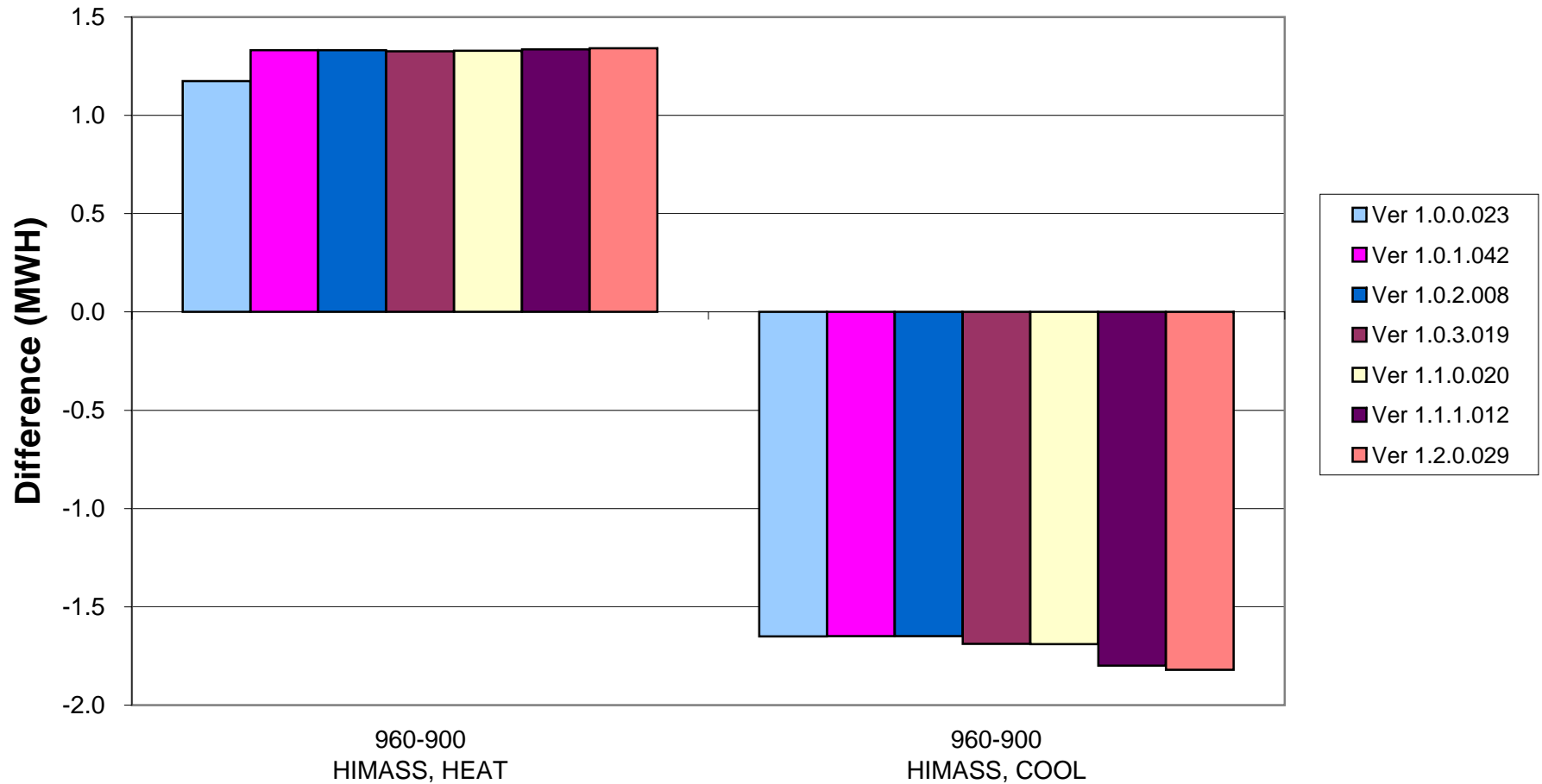

# BESTEST Comparison (Denver, dry/cold) for Release Versions of EnergyPlus Sunspace (Delta) Peak Heating and Cooling

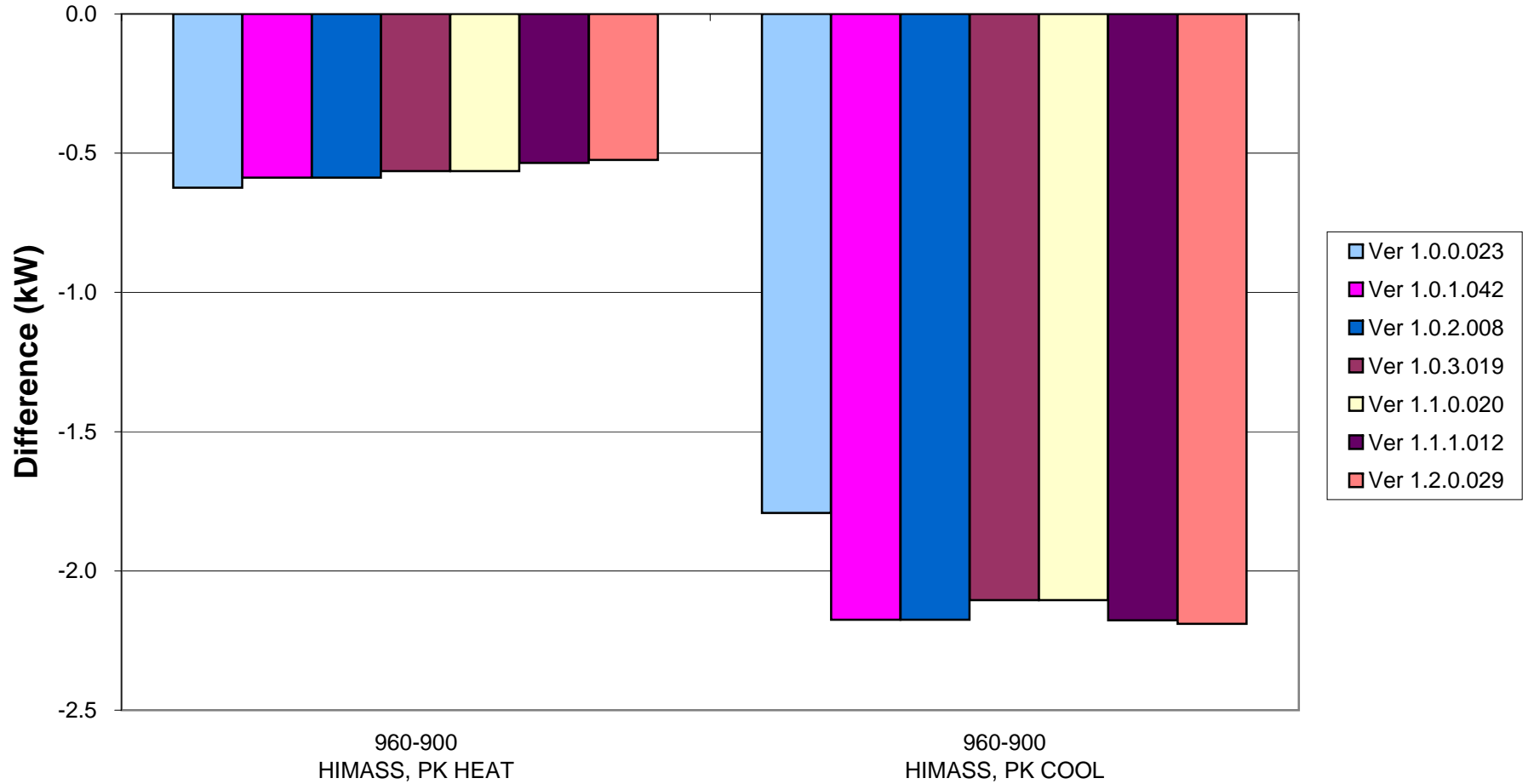



**Appendix E**

**ANSI/ASHRAE Standard 140-2001 Output Form –  
Modeling Notes**



## STANDARD 140 OUTPUT FORM – MODELING NOTES

SOFTWARE: EnergyPlus

VERSION: 1.2.0.029

---

Simulated Effect:

*Inside and outside convection algorithm*

Optional Settings or Modeling Capabilities:

*INSIDE CONVECTION ALGORITHM = Simple*

*INSIDE CONVECTION ALGORITHM = Detailed*

*INSIDE CONVECTION ALGORITHM = Ceiling Diffuser*

*INSIDE CONVECTION ALGORITHM = Trombe Wall*

*OUTSIDE CONVECTION ALGORITHM = Simple*

*OUTSIDE CONVECTION ALGORITHM = Detailed*

Setting or Capability Used:

*INSIDE CONVECTION ALGORITHM = Detailed*

*OUTSIDE CONVECTION ALGORITHM = Detailed*

Physical Meaning of Option Used:

*Detailed calculation methods are used rather than the more simple ASHRAE methodology.*

---

Simulated Effect:

*Solar distribution effects for shade surfaces*

Optional Settings or Modeling Capabilities:

*SOLAR DISTRIBUTION = MinimalShadowing*

*SOLAR DISTRIBUTION = FullExterior*

*SOLAR DISTRIBUTION = FullInteriorAndExterior*

Setting or Capability Used:

*SOLAR DISTRIBUTION = FullInteriorAndExterior*

Physical Meaning of Option Used:

*Full interior and exterior shadow calculations are performed each hour.*

---

---

Simulated Effect:

*Calculating resulting zone temperature.*

Optional Settings or Modeling Capabilities:

*ZONE VOLUME CAPACITANCE MULTIPLIER >= 1*  
*ZONE VOLUME CAPACITANCE MULTIPLIER = 1*

Setting or Capability Used:

*ZONE VOLUME CAPACITANCE MULTIPLIER = 1*

Physical Meaning of Option Used:

*Used for stability in predictor corrector step by increasing reactive capacity of zone*

---

Simulated Effect:

*Various variables used to describe properties of surfaces.*

Optional Settings or Modeling Capabilities:

*Absorptance:Visible = 0.0 to 1.0*

Setting or Capability Used:

*Absorptance:Visible = Absorptance:Solar = 0.6*

Physical Meaning of Option Used:

*Solar Absorptance – property of surface describing ability to absorb incident solar radiation*

---



---

Simulated Effect:

*Simulation time increment.*

Optional Settings or Modeling Capabilities:

*TIMESTEP IN HOUR = whole number between 1 and 60*

Setting or Capability Used:

*TIMESTEP IN HOUR = 4*

Physical Meaning of Option Used:

*The simulation time increment is 15 minutes. Outputs were set to report hourly.*

---

Simulated Effect:

*Frequency of solar and shadow calculations.*

Optional Settings or Modeling Capabilities:

*SHADOWING CALCULATIONS >= 1 (default = 20, every 20 days)*

Setting or Capability Used:

*SHADOWING CALCULATIONS = 20 (default)*

*Changed to 1 starting with version 1.0.0.026.*

Physical Meaning of Option Used:

*Solar and shadow calculations frequency done based on value set.*

---

-----  
Simulated Effect:

*Window properties for double pane glazing made of standard 1/8" (3mm) clear glass with 1/2" (13mm) air gap.*

Optional Settings or Modeling Capabilities:

*EnergyPlus requires window properties for front and back of window surfacw.*

Setting or Capability Used:

*Window properties were described as follows:*

MATERIAL:WINDOWGLASS,

Glass Type 1,	!A1 [NAME] BESTEST CLEAR 1/8 IN
SpectralAverage,	!A2 [Optical data type {SpectralAverage or Spectral}]
,	!A3 [Name of spectral data set when Optical Data Type = Spectral].
	MATERIAL:WINDOWGLASS, BESTEST CLEAR 1/8 IN
0.003175,	!N1 [Thickness {m}] 1/8"
0.86156,	!N2 [Solar transmittance at normal incidence]
0.07846,	!N3 [Solar reflectance at normal incidence: front side, calc from n=1.526, Tsol=.86156]
0.07846,	!N4 [Solar reflectance at normal incidence: back side]
0.91325,	!N5 [Visible transmittance at normal incidence, scaled from Window4 ID=1]
0.08200,	!N6 [Visible reflectance at normal incidence: front side, based on Window4 ID=14]
0.08200,	!N7 [Visible reflectance at normal incidence: back side]
0.0,	!N8 [IR transmittance at normal incidence]
0.84,	!N9 [IR emittance: front side]
0.84,	!N10 [IR emittance: back side]
1.06;	!N11 [Conductivity {W/m-K}]

MATERIAL:WINDOWGAS,

Air Space Resistance,	!A1 [Name] BESTEST AIR GAP 1/2 IN
AIR,	!A2 [Gas type (Air - Argon - Krypton - Xenon - SF6 - Custom)]
0.013,	!N1 [Gap width {m}] 1/2 inch

CONSTRUCTION, BESTEST DOUBLE PANE, ! Material layer names follow:

Glass Type 1,  
Air Space Resistance,  
Glass Type 1;

Physical Meaning of Option Used:

*Description of window properties for double pane clear glass window for determining solar and conduction heat gain.*

-----

---

Simulated Effect:

*Ground Reflectance.*

Optional Settings or Modeling Capabilities:

*Ground Reflectance: = 0.0 to 1.0*

Setting or Capability Used:

*Prior to version 1.0.1.040, GROUND REFLECTANCE = Default (Jan & Feb 0.6, Mar 0.4, Apr 0.3, May – Nov 0.2, Dec .04)*

*Version 1.0.1.040 and following, GROUND REFLECTANCE = 0.20*

Physical Meaning of Option Used:

*Property of ground surface describing amount of incident solar that is reflected.*

---